



FIRETRON[®] PLUS FT9000 SERIES COMBUSTION ANALYZERS

ANALYZER SHOWN WITH OPTIONAL AUTO-DRAINING WATER TRAP

DESCRIPTION

The Fireeye Firetron Plus series of portable combustion analyzers offer the commercial and industrial combustion technician a rugged, fast and accurate method to determine the performance level of any typical fuel burning system. The Firetron Plus uses proven highly accurate long lasting electro-chemical cells. The CO cell is Hydrogen compensated for proper resistance to cross contamination and includes a facility to view the Hydrogen compensator's life span. Every model includes a draft sensor with a range of -2- to +35 inches water gauge.

The handset is connected to the analyzer by either a fifteen or thirty foot cable (supplied) and can be configured to display four parameters per page, or customized to scroll through any or all parameters item by item. To ensure a fast response time, the analyzer is connected to the flue by a fifteen-foot hose and cable. A thirty-foot hose and cable assembly is also available. These combined features allow the technician to make adjustments to the fuel burning system right at the burner and see the results almost immediately. The Firetron Plus's standard high temperature (1100 C, 2012 F) probe is 11.5 inches (292mm) and includes a smoke test feature. Other probe lengths are available.

The Firetron Plus features a data logging facility, which can store for later retrieval, up to 1296 complete combustion tests. The data is stored in the handset and can be used without the analyzer for review or downloading to a PC. Download to a PC requires the optional Fireworks software. Data logging can be accomplished either manually or through the "Auto Log" function. "Auto Log" logging continues until stopped manually or the memory is full. Logging can also be performed to the on board dot matrix printer. Fireeye's new Fireworks software is the easiest way to see data from your Firetron on a PC. You can transfer data from the handset, see data in "real time" or see previously stored data.

Fireworks uses Windows software giving full flexibility to view, manage and report on boiler performance and emissions data. Producing graphs or reports takes the press of a button.

Simply connect the Firetron RS232 port to your PC's serial port to view data in "real time", updated every second - Perfect if you use a laptop PC to view boiler performance data.

Once data is loaded it can be viewed on screen or used to generate reports. Once the data is analyzed reports can be generated to give your client a spot check or boiler tuning, i.e. before or after results. Copies of the report can be generated on site or more commonly back in the office to be sent with other information such as work reports and invoices. Data and reports can be stored as reporter files for future use or saved to other formats for use in word processors or spreadsheets, or transfer data stored in the Firetron handset via the PC serial port.

ANALYZER LAYOUT AND FEATURES

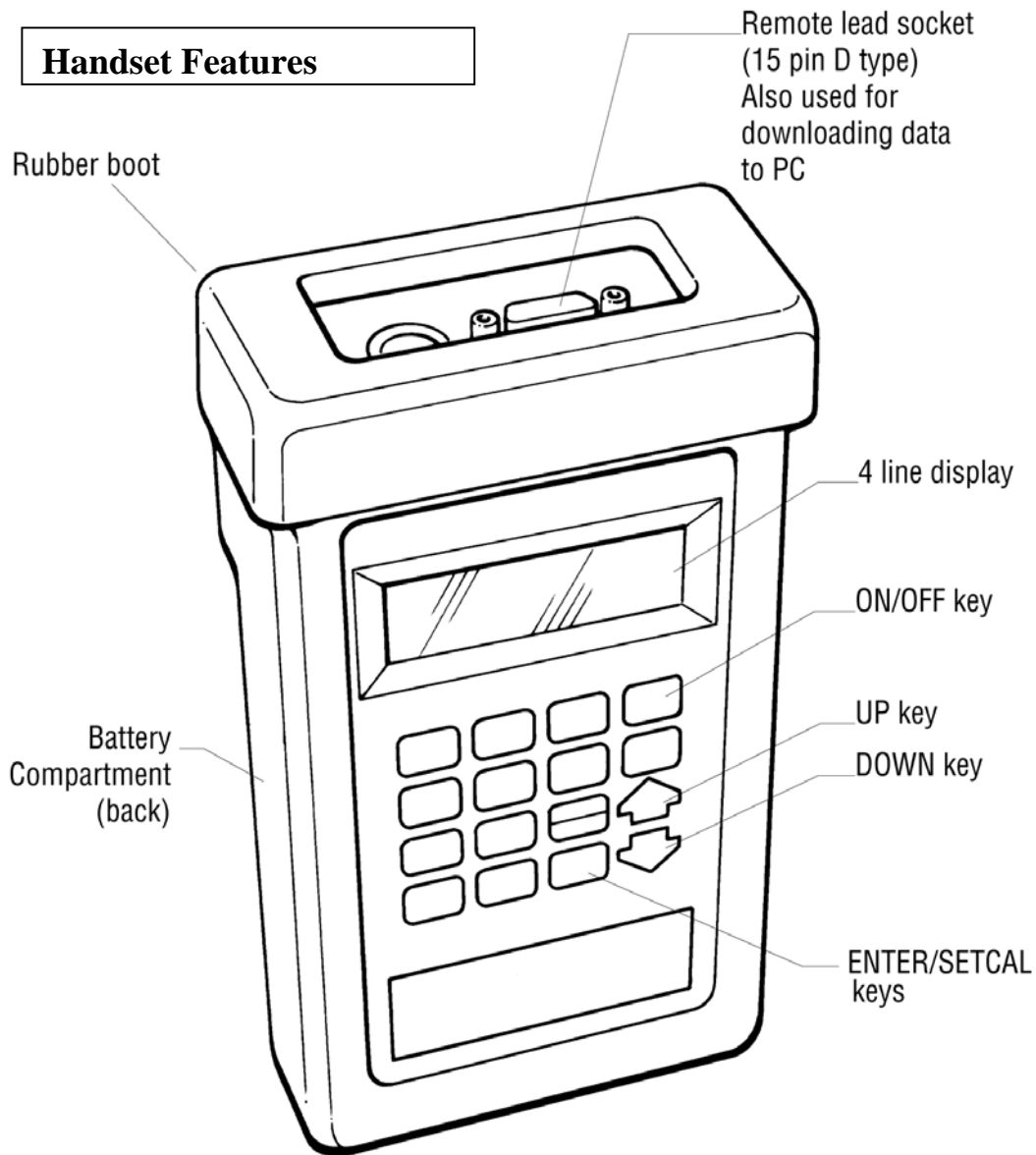

Commonly used keys



ON/OFF



UP

Pages up through screens
Scrolls up through options, i.e. Fuel



ENTER & SET/CAL

Accepts parameters
Enters values



DOWN

Pages down through screens
Scrolls down through options

Analyzer Layout

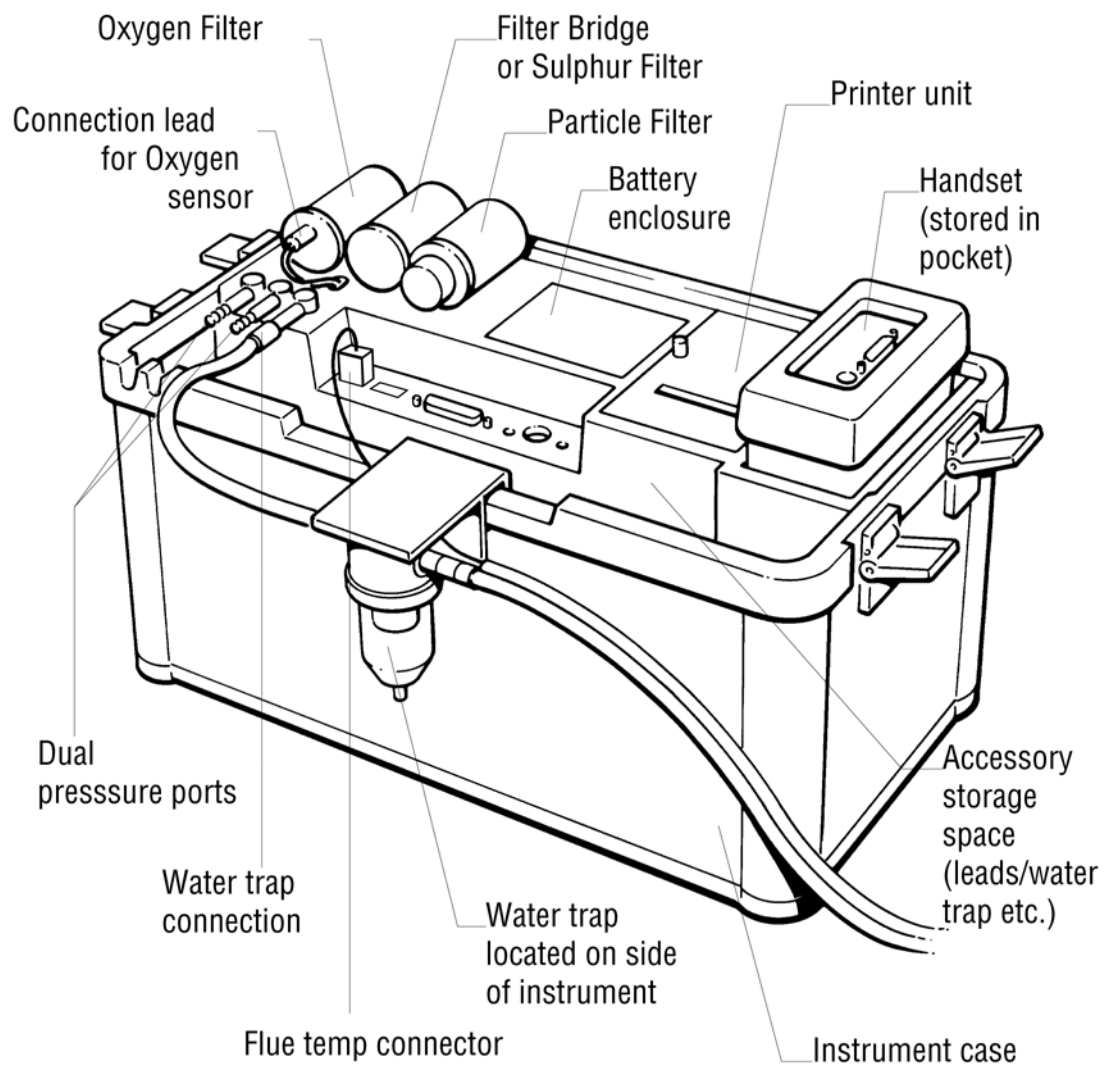

Standard Probe Configuration

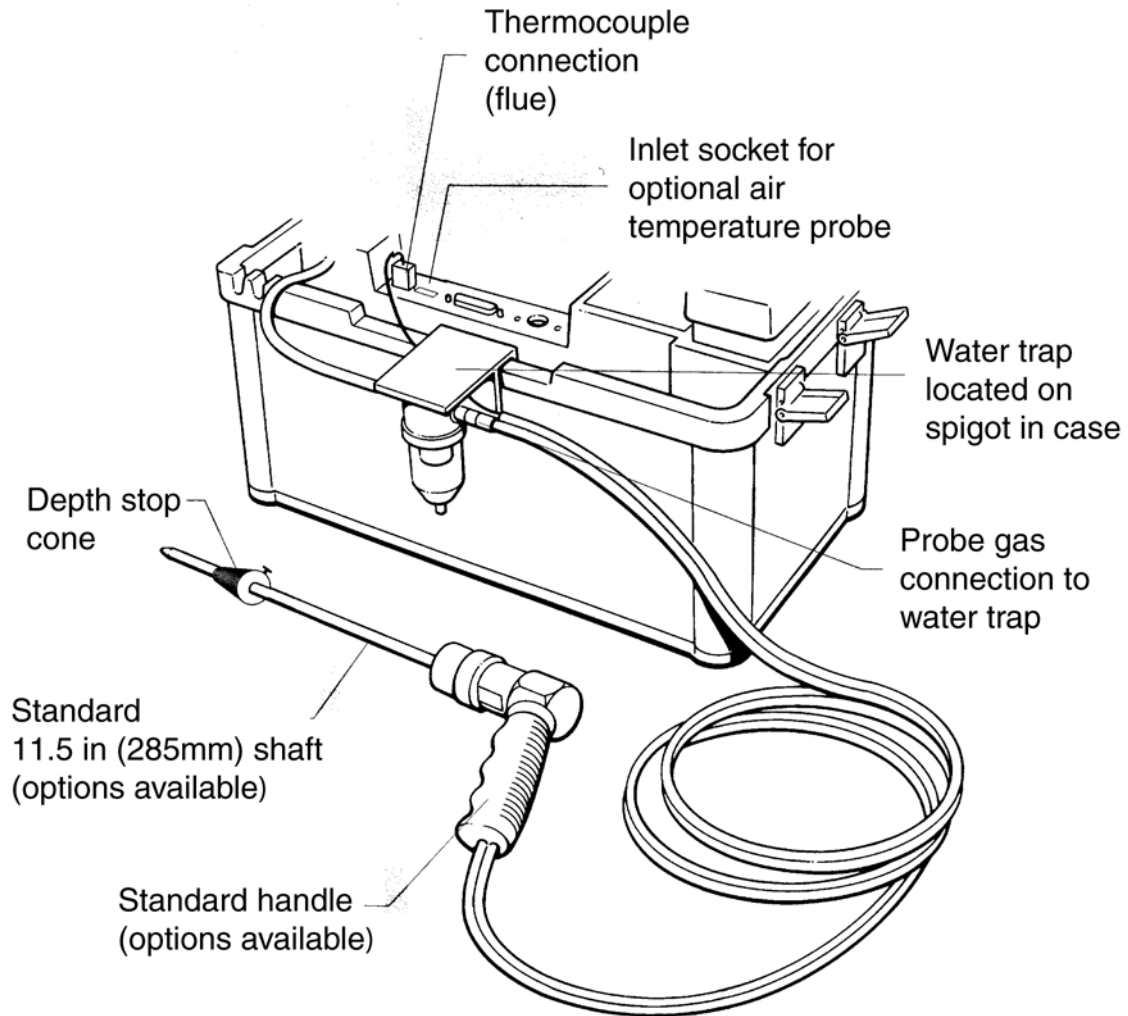

Analyzer Connection

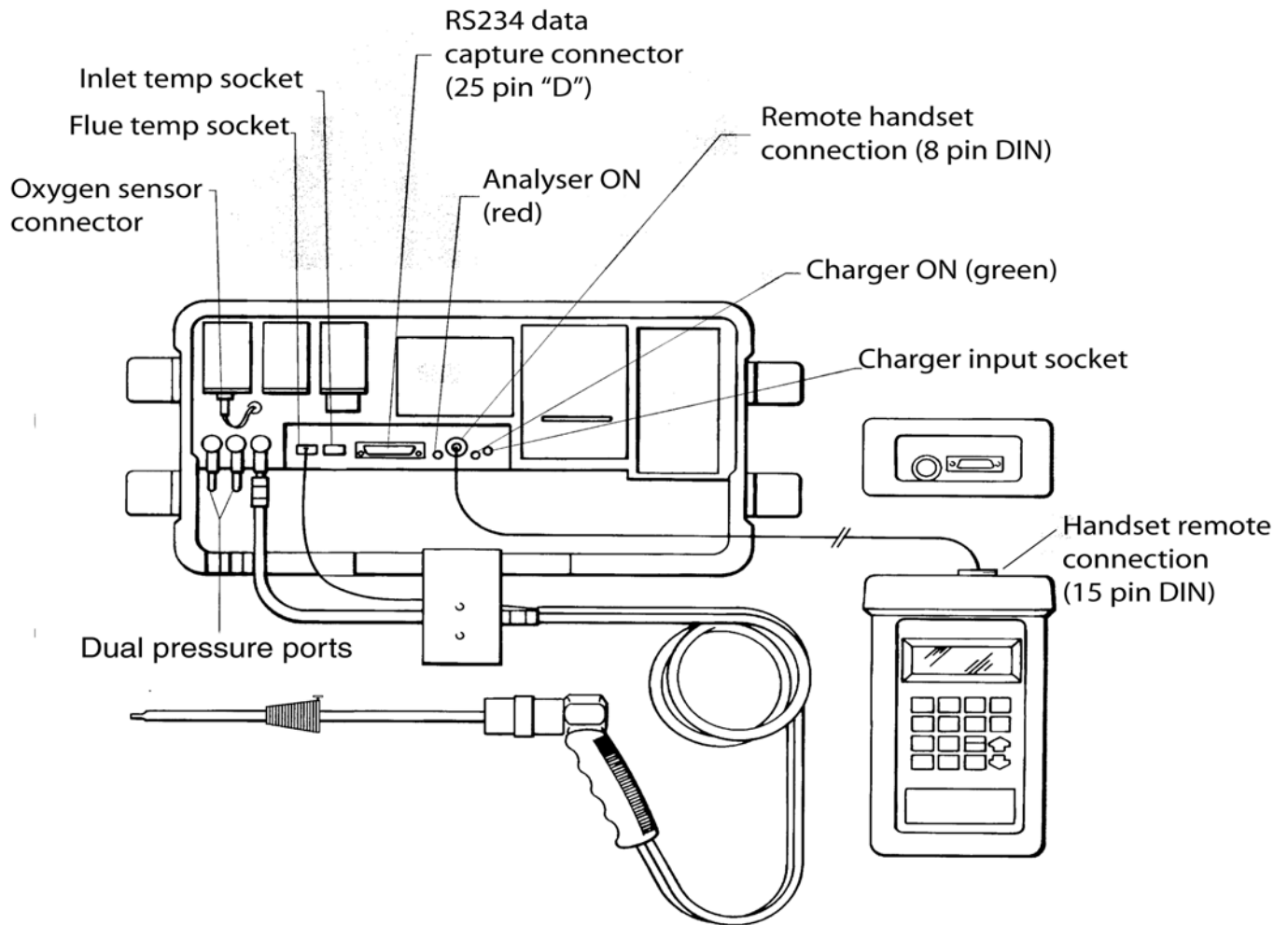

SAFETY WARNING



This analyzer extracts combustion gases that may be toxic in relatively low concentrations. These gases are exhausted from the bottom of the instrument. This instrument must only be used in well-ventilated locations. It must only be used by trained and competent persons after due consideration of all the potential hazards.

FIRST TIME USE

Charge the battery for 12 hours; following this an overnight charge should be sufficient for an average 8-hour day.

While charging the green LED will be illuminated, the LED will flash when the battery is fully charged.

Check that you have all the items you have ordered.

We offer a wide choice of probes, which are not supplied as standard and must be ordered as a separate item.

Take time to read this manual fully.

TIP: Take a look at the Spare Parts list and order some replacement filters and paper rolls now.

When using the analyzer for the first time you have the following under your control:

PARAMETER
Display Contrast
Backlight
Language
Line Rejection for mains frequency
Gas Measurement Scale
Temperature scale
Pressure scale
Reference oxygen
Time and date
Printed header name and telephone number



NORMAL START UP SEQUENCE

Every Time You Use the Analyzer – Before Switch-on check that:

- the Oxygen sensor is connected
- the particle filter is not dirty
- the sulfur filter is fitted for heavy oil or coal
- the water trap and probe line are empty of water
- all hose connections, etc, are properly made
- the paper roll is fitted
- **the probe is sampling ambient FRESH air**
- the water trap is vertical
- the flue temperature is connected
- the instrument is placed on a clean, flat, level surface

Switch the instrument ON by pressing



Automatic Calibration

During this sequence the analyzer pumps fresh air into the sensors to allow toxic sensors to be set to zero and the Oxygen sensor to be set to 20.9 %.



After switch-on the analyzer will briefly display the Fireeye® logo and telephone numbers:

***** FIREYE***
TEL (603) 432-4100
FAX (603) 432-1570**

Followed by the logger menu screen:

*** * SELECT FUNCTION * *
1 LOGGER CONTROL
2. FIRETRON PLUS CNTROL**



Use the  and  keys to position the cursor over **2 . Firetron Plus Control**.

Press  to access Firetron Plus Control

```
*** SELECT FUNCTION ***
1 LOGGER CONTROL
2 FIRETRON PLUS CNTROL
```

And show the countdown screen:

```
-----
* CALIBRATING *
          300
-----
```

The display will countdown from 300 to zero in one-second steps. If the analyzer has been used recently it may complete automatic calibration in less than 300 seconds otherwise it will count to zero.

Once the calibration sequence is complete an audible beep will be heard and will show the selected fuel on the following display:

```
-----
NATURAL GAS
PRESS ENTER KEY
-----
```

Press 

This zeros the toxic sensors and sets Oxygen to 20.9%. The next screen is the **MAIN DISPLAY** of the analyzer:

```
DATE    ... 07-08-96
TIME    ... 12:31:35
INSTABILITY    0
BATTERY % .. 54
```

MAIN DISPLAY

NOTE : It is advisable to repeat Oxygen Calibration every 2 hours for maximum accuracy.

This can be accomplished by removing or disconnecting the probe from the stack. The display should return to 20.9%. See page 28 for further information.

Use  and  to change the display.

```
NET    F    .... 0.0
O2     %    ... 20.9
CO     ppm  ... 0000
EFF (G) %  ... 0.0
```

All parameters are detailed in Appendix A - MAIN DISPLAY PARAMETERS.

Main Displays



The main display can be changed to show the following:

- **Page Mode** displays 4 lines of data in set format, each page is predefined.
- **Line scroll mode** allows you to customize the display with the data you require.

To change between the different modes:

Press  followed by 



PAGE MODE
SET

The  and  keys change between Page and Line Scroll Modes

Press  to select

LINE SCROLL MODE
SET

Page Mode

Use the  and  keys to change the information displayed on the screen. The following are a number of the pages available. Other parameters on other screens are detailed in Appendix A.

NET	F	...	0.0
O2	%	...	20.9
CO	ppm	..	0000
EFF (G)	%	...	0.0

CO2	%	...	0.0
FLUE	F	...	0.0
INLT	NOT FITTED		
AMBIENT	F	...	78



CO/CO2	R	..	0.0001
P INDEX	%	...	0.01
XAIR	%	...	0.0
Prs	inH2O		0.00

This screen only shows readings if optional sensors are fitted. In this instance the SO2 sensor is NOT FITTED.

NO	ppm ..	0000
NO2	ppm ..	0000
NOx	ppm ..	0000
SO2	NOT FITTED	

Line Scroll Mode

Line scroll mode allows you to customize the display.

Use the  key to change the bottom line of the display. Once the correct line is displayed press  to confirm and move the line up. Select the next parameter and repeat until all lines display the desired parameters.

Change bottom line using 

NET	F ...	0.0
O2	% ...	20.9
CO	ppm ..	0000
CO2	% ...	0.0

to select and move parameter up 

O2	% ...	20.9
CO	ppm ..	0000
CO2	% ...	0.0
CO2	% ...	0.0

Select next parameter.
Repeat above until display reads desired data

O2	% ...	20.9
CO	ppm ..	0000
CO2	% ...	0.0
CO/CO2 R	..	0.0001

Sampling the Flue Gas

Once the automatic calibration procedure has been completed and the specific fuel has been selected the probe can be inserted into the desired sampling point.

It is recommended that the sampling point be located at least two flue diameters downstream of any bend and that the probe tip is in the center of the flue (this is normally the point of the hottest temperature). With balanced flues and other domestic units the probe should be positioned far enough into the flue so that no air can ‘back flush’ into the probe.

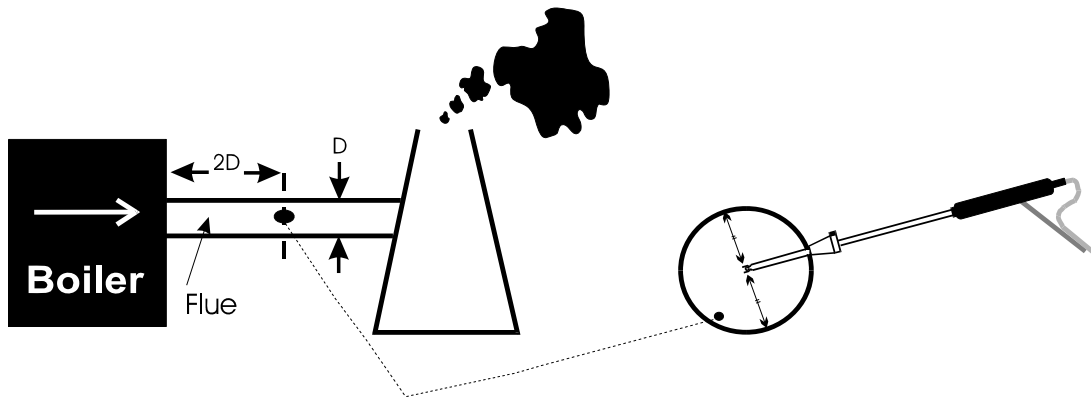

The probe depth stop cone provided with the instrument allows the probe to be used in holes whose diameters range from 8 mm to 21 mm ($\frac{5}{16}$ to $\frac{13}{16}$ inch).

The standard probe is rated at 650°C/1202°F. Temperatures of up to 1100°C/2012°F can be accommodated using an optional high temperature probe.

TIP: To conserve battery power, switch the pump off when you are not taking a measurement. Use the  key to turn the pump ON and OFF.



Taking a Pressure Reading

With the optional pressure module fitted a flue draft measurement can be made at any time.

Connect the standard probe to the appropriate pressure sensor inlet and place the probe in the flue.

The pressure reading will be displayed:

CO/CO2 R	..	0.0001
P INDEX %	...	0.01
XAIR %	...	0.0
Prs	inH2O	0.00



NOTE: Care must be taken to connect the probe to the correct port, as the pressure will be displayed in reverse i.e. a positive pressure rather than negative draft.

To perform a combustion test and display draft pressure at the same time a special probe is required. Contact Fireeye® or an Authorized Distributor for details.

Two pressure ports are provided on the instrument for use with a Pitot tube. Contact Fireeye® for details of this probe and its availability.

Regular Checks During Sampling

Care must be taken at all times not to exceed the analyzer's operating specification. In particular ensure the following:

- Do not exceed the maximum temperature of the flue probe.
- The analyzer's internal temperature does not exceed normal operating range, typically 0-40°C (32-104°F).
- DO NOT PLACE THE ANALYZER ON A HOT SURFACE.
- **The water trap is vertical at all times. Water condenses in the probe line and can quickly fill the water trap when the probe is moved. Take care and watch the water trap closely.**
- The in-line particle filter is clean and does not become blocked.

NOTE: For use where the instrument will be in service for extended periods, especially on Fuels with high moisture content, an optional auto draining water trap is recommended. Contact Fireeye or an Authorized Distributor for details.



Normal Shutdown Sequence

DO THIS EVERY TIME YOU USE THE ANALYZER.

Remove the probe from the flue - **TAKE CARE ! THE PROBE WILL BE HOT** - and allow it to cool naturally. Do not immerse the probe in water, as this will be drawn into the analyzer and damage the pump and sensors.

Once the probe is removed from the flue, the oxygen reading 20.9% and the CO reading is zero press and the analyzer will switch off.

Check the water trap and probe tubes for water before packing away.

Electromagnetic Compatibility

The European Council Directive 89/336/EEC requires that electronic equipment does not generate electromagnetic disturbances that exceed defined levels and has an adequate level of immunity to enable it to be operated as intended. The specific standards applicable to this product are detailed in the appendices.

Since there are many electrical products in use that pre-date this Directive and may emit electromagnetic radiation in excess of the standards defined in the Directive there may be occasions where it would be appropriate to check the analyzer prior to use. The following procedure should be adopted:

Go through the normal start up sequence in the location where the equipment is to be used.

Switch on all localized electrical equipment that might be capable of causing interference.

Check that all readings are as expected. (A level of disturbance in the readings is acceptable). If not adjust the position of the instrument to minimize interference or switch off, if possible, the offending equipment, such as Variable Speed Drives, Ignition Transformers etc, for the duration of the test.

Note: Maximum cable lengths must be less than 3 meters (9 ft).

At the time of writing this manual (January 1997) Fireye Inc. is not aware of any field based situation where such interference has ever occurred and this advice is only given to satisfy the requirements of the Directive.

HC104 Module

With this module fitted and working the CO₂ value is always the measured value not the calculated value. The handset display and print out indicate that the CO₂ value is a measured value by showing CO₂m. If the module is not fitted, the Firetron Plus automatically defaults to calculated CO₂. If during start up calibration a fault is detected in the CO₂ module, the instrument will default to calculated. If the instrument displays CO₂m FAULT during operation, by switching OFF and then ON, the instrument will default to calculated CO₂

USING THE KEYPAD

Basic Operation

Basic operation of the keypad to change the display in PAGE and LINE SCROLL mode is detailed on pages 9 and 10. These modes give you the facility to perform the following:

- **Page Mode** displays 4 lines of data in set format, each page is predefined.
- **Line scroll mode** allows you to customize the display with the data you require.

QUICK key operation

To allow parameters to be viewed quickly Firetron Plus has a number of QUICK keys. Many of these keys have two functions.

To select an **LOWER PARAMETER** parameter simply press the key i.e.

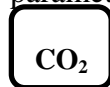
 to display CO₂ and three other values

CO2	%	...	20.9
CO	ppm	...	0000
NET	F	0.0
XAIR		O2 >	20%

To select a **UPPER PARAMETER** parameter press the **UPPER FUNCTION** key

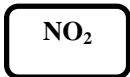

UPPER FUNCTION			

Followed by the **UPPER PARAMETER** you require parameter key i.e.  to display NO₂ and three other values

NO2	ppm	0
NO	ppm	0
NET	F	0.0
CO	ppm	0

Other QUICK keys are detailed below:

LOWER PARAMETER KEYS

NET	to display Net temperature plus O ₂ , CO and Eff.
FLUE	to display Flue temperature plus Ambient, O ₂ and Prs.
INLET	to display Inlet temperature plus Ambient, O ₂ and Flue
O₂	to display Oxygen reading plus CO, CO ₂ and Net
CO₂	to display Carbon Dioxide calculation or reading CO, Net and XAIR
CO	to display Carbon Monoxide plus Net, O ₂ and CO ₂
AUX	to display AUX1 and CxHy readings plus Net and CO
FUEL	to display chosen fuel and its parameters
EFF	to display Gross efficiency plus O ₂ and CO

UPPER PARAMETER KEYS

ALWAYS Press **UPPER FUNCTION**  first then

SCALE	to display Scaling setup parameters
AMBIENT	to display ambient temperature plus sensor, Flue and Inlet
SO₂	to display Sulfur Dioxide reading plus Net, O ₂ and CO
NO₂	to display Nitrogen Dioxide reading plus NO, Net and CO
NO	to display Nitric Oxide reading plus NO _x , Net and CO
NO_x	to display the Oxides of Nitrogen reading plus NO, CO and Net
PRESSURE	to display the pressure reading plus Flue, Net and O ₂
LOSSES	to display all four losses
λ	to display Excess Air plus CO, Eff and CO ₂ .

All measured and calculated values are detailed in Appendix A - Main Display Parameters.

DISPLAY HOLD

The display hold function allows you to freeze values on the instrument allowing them to be viewed or printed. No measurements are taken once this function has been activated. This feature gives the following benefits:

- Data can be viewed at a particular point in the boiler tuning process.
- Multiple printouts may be obtained of the same data.
- Scales can be changed between printouts giving different units. i.e. ppm and mg/m³

TO TOGGLE DISPLAY HOLD

Press **UPPER FUNCTION**  followed by 

Indicates the display is held.

# NET	F	...	0.0 #
# O ₂	%	...	20.9 #
# CO	ppm	..	0000 #
# EFF (G)	%	...	0.0 #

In this function only the battery level will be updated and all other parameters are frozen. This does not apply when AUTOPRINT is ON, the time and date are also updated in this mode.

DISPLAY BACKLIGHT AND CONTRAST

The **display contrast** can be adjusted to suit different lighting conditions and the **backlight** can be switched on or off.

TO TOGGLE THE BACKLIGHT ON /OFF

Press UPPER FUNCTION  followed by 

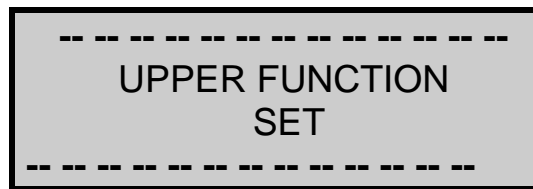

TO SET THE CONTRAST

Press the  followed by
UPPER FUNCTION key



Pressing the  key displays



Hold down either the  or  key and release once the desired level is set.

Press  to confirm setting.

NOTE: The screen may flip from all dark to blank very quickly. **Do not panic this is normal** - keep pressing the same key until the desired level is displayed.

TIP: **If for any reason the display is not visible at switch on, simply disconnect the handset for a few seconds and re-connect. Then reset the display contrast as detailed above.**

PUMP

The **Pump** can be toggled on or off from the handset.

TO TOGGLE THE PUMP ON /OFF

Press 



TIP: When the pump is switched off the O₂ reading will go down as the oxygen sensor consumes the oxygen in its housing! This is normal.

USER SELECTABLE SETTING

The following features are under your control at any time and can be changed as detailed later in this section.

Time and date	Day/ Month order is selectable and the real time clock and calendar are fully adjustable.
Fuel type	Standard pre-programmed fuels can be selected or users can define their own fuel characteristics.
Efficiency	Efficiency readings can be selected to be based on Gross or Net values. <i>Note: In the United States Gross Eff. is generally used.</i>
Language	The analyzer is programmed with ten languages.
Line Rejection	For optimum main electricity noise rejection a software filter set for either 50 Hz or 60 Hz. Select 50 Hz in Europe and 60 Hz in the USA. Check your country's power frequency.
Gas Scale ppm(n) or mg/m ³ (n)	Normalized or un-normalised ppm or mg/m ³ scaling can be selected. Normalized is also known as referenced readings to Oxygen. See Reference Oxygen below.
Compensation	Some sensors are cross sensitive to other gases. Where appropriate sensors are fitted so this cross sensitivity can be compensated for, improving accuracy. During re-calibration this compensation must be disabled.
Temperature scale	The analyzer is programmed for both Celsius and Fahrenheit
Pressure scale	The analyzer is programmed for inWG, mBar, cmWG and kPa.
Reference oxygen	Toxic gas measurements can be referenced to defined oxygen levels.
NO_x Calculation	Determines the level for calculating NO _x . Depends on the sensors fitted and local authority preferences.
Inlet temperature	The flue temperature probe can be used to measure and programmed the air inlet temperature to the boiler

Oxygen calibration

If the analyzer is being used for multiple checks over the working day it is advisable to re-set the oxygen sensor at regular intervals. This function allows re-set without the need to repeat the start-up routine



Toxic sensor zero

The CO and other optional toxic sensors can be reset to zero if they drift. This may happen if the sensor is taken to very high concentrations for long periods of time or over-ranged.

Time and Date (Setting numbers)

This section gives details on setting the time and date and also the general principle of setting a number from 0-9 used in other functions.



TO SET THE TIME AND DATE

Press the  followed by  UPPER FUNCTION key

UPPER FUNCTION
SET

Pressing the  key displays



DAY - MONTH - YEAR
SELECT ORDER

Parameter	Controls	Options
DATE FORMAT:	Select using  or  key and 	DAY-MONTH-YEAR MONTH-DAY-YEAR

To Set The Date:

DATE 26-01-97
 SET

Each number in the date is to be set. The cursor _ under the two in the DAY above indicates this number can be changed. Set each number in the date until correct using the method below, this is also the method for **SETTING NUMBERS**.

Parameter	Controls	Options
DATE:	Select each number using  or  key and 	0 - 9

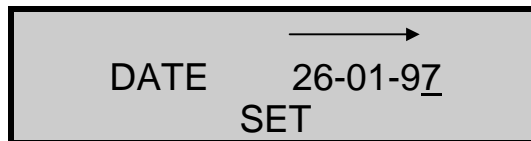

The cursor moves to each number in turn until the last number is set.

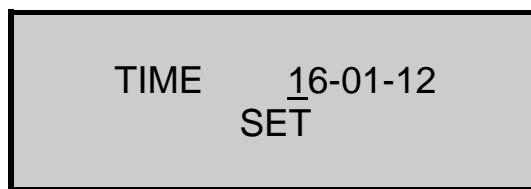

To Set The Time:



As with the date each number in the time is to be set.

Parameter	Controls	Options
TIME:	Select each number using  or  key and 	0 - 9

Once the last number has been set the screen will show the main display last shown before entering the set time routine.

Changing a fuel

This section gives details on changing a standard fuel and entering a user fuel.

TO SET THE FUEL

Press the 

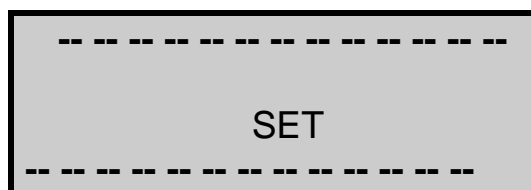





Pressing the **FUEL** key displays





STANDARD OR USER?
STANDARD FUEL

Parameter	Controls	Options
FUEL STANDARD	Select using  or  key and 	STANDARD FUEL USER FUEL



To Set A Standard Fuel:

There are over 70 standard fuels programmed into Firetron Plus. The fuels are arranged into tables for each country and the table should be selected for the origin of the fuel used in your boiler. Each table contains different fuel types; choose the fuel that is closest to the fuel used in your boiler.

SELECT FUEL TABLE
ENGLISH

Parameter	Controls	Options
FUEL TABLE:	Select table for your country using  or  key and 	ENGLISH FRANCAIS DEUTSCH NEDERLANDS ITALIANO CASTELLANO SVENSKA SUOMI OESTERREICH NEW ZEALAND

SELECT FUEL TYPE
NATURAL GAS



Parameter	Controls	Options for English Fuel Table
FUEL TYPE:	Select fuel type using  or  key and 	NATURAL GAS NATURAL GAS 2 TOWN GAS LIGHT OIL HEAVY OIL COAL ANTHRACITE COKE PROPANE BUTANE GASCOR LPG

The table shown above is for the UK. Fuel lists vary depending on the country. Use **this list for North America.**

To Set A User Fuel:

If one of the standard fuels does not approximate to the one you are using in your boiler then it is possible to set the Firetron Plus up for a USER FUEL. The information required to be able to set this are the Chemical Breakdown of the fuel and the Gross and Net calorific value. Details of the calculation are shown in the Appendix.

SET			
K1g	0.350	K1n	0.393
K2	11.89	K3	9.83
K4	32	O2r	3.0

Parameter	Controls	Options
USER FUEL:	Set each number as date using  or  key and 	0 - 9

TIP: If you enter this routine in error, ENTER past all of the numbers to exit.

Check fuel set by pressing



NATURAL GAS			
K1g	0.350	K1n	0.393
K2	11.89	K3	9.83
K4	32	O2r	3.0

Gross or Net Efficiency

The Firetron Plus can calculate efficiency in one of two ways.

Efficiency = 100% - Losses. See the Appendix for the Efficiency calculation.

- Gross efficiency uses the gross calorific value of the fuel and deems that the latent heat of vaporization is lost up the flue of the boiler and is taken as a loss. Gross is used in the UK and USA.
- Net Efficiency uses the net calorific value and assumes the latent heat is not lost up the flue. For Natural gas this efficiency can be 11% higher than the Gross figure. Net is used in France and Germany.

NOTE: Latent heat is the heat required to turn water at 100°C (212°F) into steam at 100°C (212°F), i.e. a change of state from liquid to vapor without rise in temperature has taken place.

TO SET GROSS OR NET EFFICIENCY

Press the

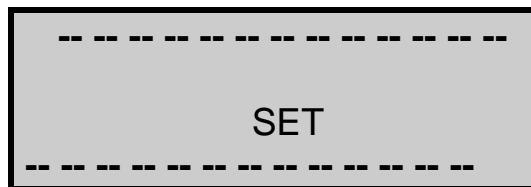

Pressing the



key displays

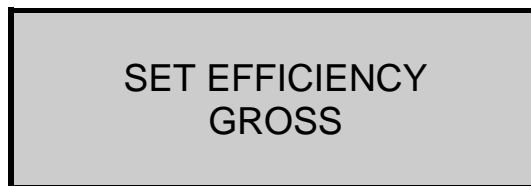

Parameter	Controls	Options
EFF	Select using or key and	GROSS NET

Scale Options

The scale option routine gives you control over:

- Language
- Line Rejection
- Gas Scale
- Compensation
- Temperature Scale
- Pressure Scale
- Reference Oxygen
- NOx calculation

TO SELECT SCALE OPTIONS

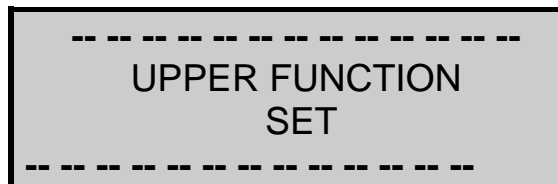

Press the **SET/CAL** followed by





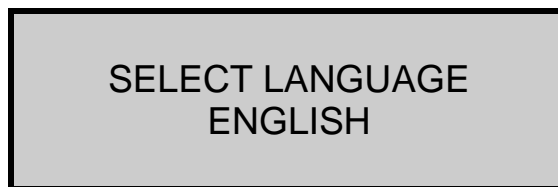

UPPER FUNCTION key

Pressing the **SCALE** key displays

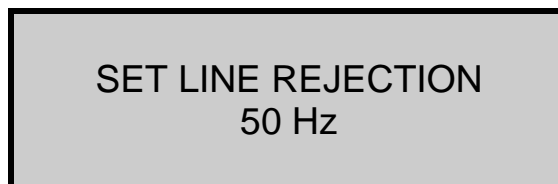



Parameter	Controls	Options
SELECT LANGUAGE	Select using  or  key and 	ENGLISH SPANISH NETHERLANDS FRENCH ITALIAN GERMAN SWEDISH FINNISH



Parameter	Controls	Options
LINE REJECTION	Select using  or  key and 	50 Hz - UK 60 Hz - USA



ppm(n) or mg/m³(n)

Parameter	Controls	Options
GAS UNITS ppm(n) or mg/m ³ (n)	Select using  or  key and 	ppm ppm n mg/m³ mg/m³n



NOTE: ppm = parts per million
 mg/m³ = milligrams per cubic meter
 n denotes the reading is normalized or referenced to Oxygen
 See Reference Oxygen in the Appendix

On power up the unit will default to ppm.



COMPENSATION < >
< OFF >

Parameter	Controls	Options
COMPENSATION	Select using  or  key and 	OFF ON

SET TEMPERATURE
CELSIUS



Parameter	Controls	Options
TEMPERATURE	Select using  or  key and 	CELSIUS FAHRENHEIT

SET PRESSURE
mbar

Parameter	Controls	Options
PRESSURE	Select using  or  key and 	mbar inWG

NOTE: mbar = millibar
 inWG = inches of water gauge

SET REFERENCE O2
NO

Parameter	Controls	Options
REFERENCE O2	Select using  or  key and 	NO YES

Selecting YES allows you to set an oxygen reference value different to that shown in the fuel constants. For example 3% is set in the Natural Gas constants, to reference the toxic gas values to a different value select using the screen below (Use the number setting sequence as detailed in Setting Time):

SET REFERENCE O2
REF. %O2 . . 80

This may need setting if a local authority requires gas readings to be referenced to a certain oxygen value. As a general rule gaseous fuels are normally referenced to 3% oxygen.

NOTE: The readings can change dramatically if the wrong Oxygen reference is set and either ppm or mg/m³ as the gas units. If you are unsure of the reference value set ppm or mg/m³ as detailed above.

SET NO_x CALC'N
NO

Allows the calculation for NO_x to be altered. Select YES to enter the following routine.

SET NO_x REF.
REF %NO_x. = 05

With only the NO sensor fitted there is no way of measuring NO₂ and an allowance is made in the calculation of the NO_x value. This NO_x value is calculated from the formula shown below:



- $NO_x = NO + (P\% \times NO)$

where P% = REF. %NO_x and is set to 5% as default.

With both NO and NO₂ sensors fitted the formula is as follows:

- $NO_x = NO + NO_2$

SET NO_x REF
NO_x = SUM

Parameter	Controls	Options
REF NO _x	Select using  or  key and 	NO _x = SUM NO _x = NO NO _x = NO ₂

There are three ways of displaying the value of NO_x when the values are converted to mg/m³. Local authorities may require a certain calculation. The options are as follows:

- **NOx = SUM** calculates the mg/m3 figure individually from the NO and NO2 values and then adds them together.
- **NOx = NO** adds the ppm values together and then converts to NO equivalent.
- **NOx = NO2** adds the ppm values together and then converts to NO2 equivalent.

On power up the unit will default to NOx = SUM

Inlet Temperature

The Firetron Plus uses as default the internal ambient sensor when calculating the Net temperature. If an optional inlet probe is fitted then INLET is used in the calculation.

As an alternative to both of the above, the inlet air entering the boiler can be measured using the flue probe.

NOTE: The probe must not be inserted into the flue until the INLET temperature has been set. If resetting the inlet temperature after performing a combustion test ensure the tip of the probe is at the air temperature

TO SET INLET TEMPERATURE

With the flue probe connected to the FLUE temperature connector.

Press the 

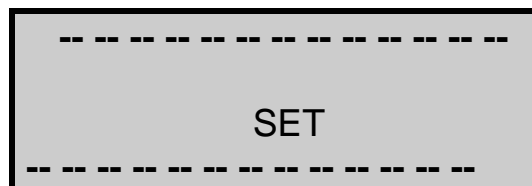

Pressing the  key displays

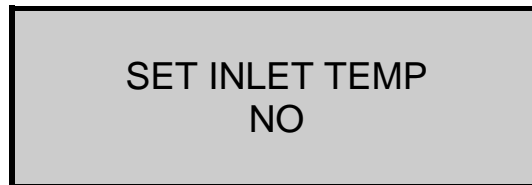

Change to YES

Position the tip of the flue probe near the Air inlet of the boiler and when the reading is stable press



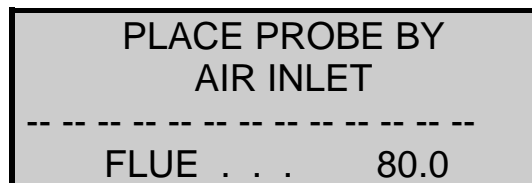

The temperature measured by the flue probe will be set in the Firetron Plus.

Press  to check the reading.



Oxygen Calibration

If used over long periods the Oxygen sensor may drift slightly and for maximum accuracy may require resetting.

TO RESET OXYGEN SENSOR

With the flue probe sampling fresh air and the flue temperature reading less than 50°C/122°F, or the temperature plug disconnected from the instrument.

Press the 

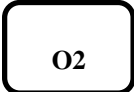

SET

Pressing the  key displays

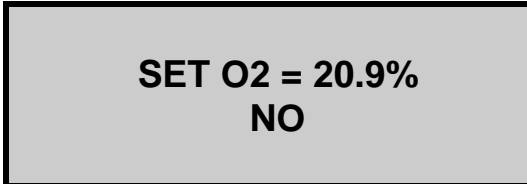

SET O2 = 20.9%
NO

Change to YES

Press  to set 20.9% Oxygen.

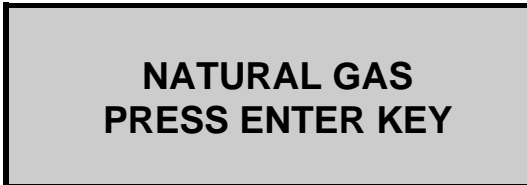

NATURAL GAS
PRESS ENTER KEY

Toxic sensor zero

WARNING: This procedure should be thoroughly understood before attempting to zero toxic cells.

The CO and other optional toxic sensors can be reset to zero if they drift. This may happen if the sensor is taken to very high concentrations for long periods of time or over-ranged.

Press  twice

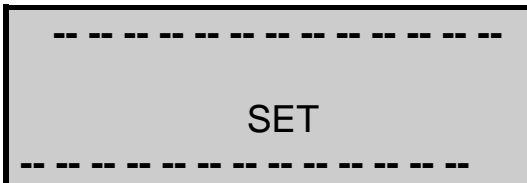



SET



ENTER SERVICE CODE
--- > 0000 < ---



Press  four times

CALIBRATE SENSOR
NO

Parameter	Controls	Options
CALIBRATE SENSOR	Select using  or  key and 	YES NO



Select YES

SET ZERO ?
NO

Parameter	Controls	Options
SET ZERO	Select using  or  key and 	YES NO

Select YES

SELECT SENSOR
CO ----- . . -17

Parameter	Controls	Options
SELECT SENSOR	Select using  or  key and 	LIST OF FITTED SENSORS DISPLAYED

In this example we have selected the CO sensor. The pump will now run if it has been turned off, this is to draw **fresh air** through the instrument to allow the sensors to be zeroed.

Ignore the reading next to the sensor

Ensure the instability reads zero

SET ZERO LEVEL
CO ----- . . -17
INSTABILITY 5
* CALIBRATING *

Once the instability has reached zero press  to accept the zero calibration and return to the main display.

If the instability does not reach zero then the instrument will show **FAULT**. Contact Fireeye® or Authorized Distributor for advice.

CO Alarm

It is possible to set a point in the range of the sensor so that it alarms and warns the user of a dangerous level of Carbon Monoxide. The default level is set at 400 ppm. This should be used when there is a local limit on the level of CO that should not be emitted from a boiler.

TO SET THE CO ALARM LEVEL

Press the 

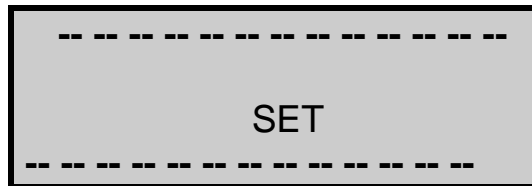

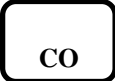
Pressing the  key displays



Set each number as detailed in Setting Time

When the CO level rises above the set values the following screen will be displayed every ten seconds. This will continue until the CO level falls below the alarm setting.

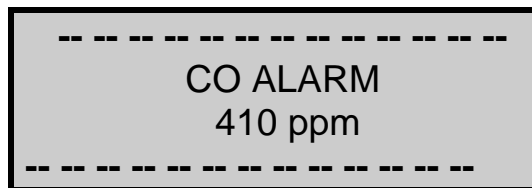



PRINTING INFORMATION

While in any of the main displays a manual print can be obtained by pressing

PRINT

The display will show the printout as it is printing:

```
*** PRINTING ***
-----
** FIREYE **
-----
```

Standard Printout

The standard printout is shown below:

```
-----
*** FIREYE ***
* FIRETRON PLUS *

DATE      02-01-97
TIME      18:14:35

NATURAL GAS

O2  % .... 20.9
CO  ppm ..... 0
Prs in WG 0.05
EFF %      FAULT

XAIR      O2 > 20%
CO2 % ..... 0.0
CO/CO2 R ... 0.0000
PI  % ..... 0.00

NO  ppm ..... 0
NO2 ppm ..... 0
NOx ppm ..... 0
SO2 ppm ..... 0
CxHy % ..... 0.0

NET F ..... 0
FLUE F ..... 21
INLT  NOT FITTED
AMBIENT F 16.9

-----
```

Setting auto-timed printing or logging

Allows information to be printed or logged automatically at set time intervals (from 10 seconds to 90 minutes). Care must be taken in setting the interval time; a standard Firetron Plus printout will take 30 seconds to print, it is advisable to set the interval at 2 minutes or greater if a print is requested. Turn off the printer if less than 2 minutes is set. If greater than 5 minutes is set the Firetron Plus will switch OFF the pump immediately after printing and switch it ON again 3 minutes before the next print.

Disabling Firetron Plus printer

If only logged information is required without a printout then the Firetron Plus integral printer can be turned OFF.

Edit the printout header

You can personalize the header on the printout to your own Company name and Telephone number. Two lines of 16 characters are available.

Changing the format of the printout

The standard printout is detailed on the previous page. You can customize a printout to your own requirements by selecting lines from the list detailed later in this section.



Changing printout parameters

Press  followed by  will display the following screens :

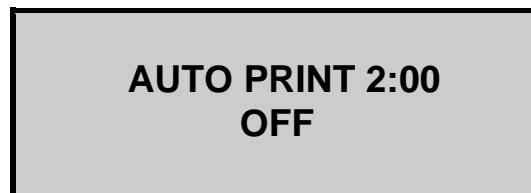
This displays the Auto print status and the interval time; for this example 2 minutes.





AUTO PRINT 2:00
OFF

Use  or  keys. To select ON or OFF and press 

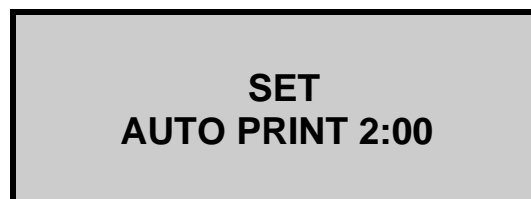
With Auto print ON the display will show:





SET
AUTO PRINT 2:00

Use  or  keys to select from 0:10 to 90:00 and press 

The next screen enables or disables the integral printer. Default is ON.



PRINTER ?
ON

Use  or  key to select **ON** or **OFF** and press

ENTER

To edit the printout header select **YES**.



SET HEADER ?
NO

Use  or  keys to select **YES** or **NO** and press

ENTER

The cursor **_** will be positioned under the first *****.

EDIT HEADER
***** FIREYE *****
*** FIRETRON PLUS ***
ENTER & EFF=BACK

Use  or  to select the alpha/numeric character required. Press **ENTER** when the character is correct. If you make a mistake the **EFF** key will take the cursor back.

ENTER

EFF

When the last character has been set the screen will display the next screen.

Entering **NO** will select the standard printout as detailed earlier in this section. The general principle for selecting a user printout is detailed below.

USER PRINTOUT ?
NO

User Defined Printouts

General Principle: A user-defined printout can have a maximum of 40 lines. The contents of each line can be defined by the user from the master list of parameters detailed later in this section. The standard printout with line numbers and parameter numbers is given later in this section as an example. To define a printout you must allocate a parameter number to each line. The printout must be terminated with a line of hashes.



Select YES to configure your own printout.

```
USER PRINTOUT ?  
YES
```

```
SET LINE ..... ?  
NO
```

If you have previously configured a printout select **NO**, selecting **YES** will allow the first line of the printout to be changed.

```
SET LINE ..... 1  
* * FIREYE * *
```

Use  or  keys to select the required line and press 

In this example the Time has been selected for the first line.

```
SET LINE ..... 1  
TIME          10:32:36
```



Repeat the process for the second line and so on.

```

SET LINE ..... 2
O2 % ..... 11.2

SET LINE ..... 3
#####
  
```

End the printout with a line of hashes.

The above example will send the Time and Oxygen reading to the printout every two minutes. To stop the Firetron Plus Auto printing or logging, select Auto print **OFF** above and return to the main displays.

Standard Printout - Parameter Options Used:

LINE NUMBER	PARAMETER USED:	(MAX LINES: 40) & STATUS:
1	-----	PRINTOUT START
2		BLANK LINE
3	***FIREYE***	MANUFACTURER ID
4	FIRETRON PLUS	ANALYZER ID
5		BLANK LINE
6	DATE 02-01-97	DATE
7	TIME 18:14:35	TIME
8		BLANK LINE
9	NATURAL GAS	FUEL SELECTED
10		BLANK LINE
11	O2 %20.9	FLUE GAS O ₂ CONTENT
12	CO ppm0.0	FLUE GAS CO CONTENT
13	Prs in WG0.05	PRESSURE MEASUREMENT
14	EFF %.....FAULT	COMBUSTION EFF CALC
15		BLANK LINE
16	XAIR O2>20%	FLUE GAS EXCESS AIR
17	CO2 %.....0.0	FLUE GAS CO ₂ CALC (CO ₂ m% FLUE GAS CO ₂ MEASURE)
18	CO/CO2 R....0.00	CO/CO ₂ RATIO
19	PI %0.00	POISON INDEX
20	NO ppm.....0	FLUE GAS NO CONTENT
21	NO20	FLUE GAS NO ₂ CONTENT
22	NOx ppm.....0	NOX CALCULATION
23	SO2 ppm.....0.0	FLUE GAS SO ₂ CONTENT
24	CxHy % 0.0	HYDROCARBON READING
25		BLANK LINE
26	NET F 0.0	NET FLUE GAS TEMP
27	FLUE F 21.0	ACTUAL FLUE GAS TEMP
28	INLT NOT FITTED	BOILER INLET TEMP
29	AMBIENT C 16.9	AMBIENT AIR TEMP
30	-----	DOTTED LINE



Not all parameters are used. See the master list that follows, if more are required.

Master List of Printed Parameters

The following list is a master list of printed parameters. Details of the measured and calculated variables are given in the Appendix.

	PRINT	DESCRIPTION
1	*** FIREYE ***	COMPANY IDENTIFICATION
2	FIRETRON PLUS	ANALYZER IDENTIFICATION
3	BLANK	BLANK LINE
4	DATE	DATE
5	TIME	TIME
6	INSTABILITY	FLUE GAS STABILITY STATUS
7	BATTERY	BATTERY STATUS
8	OS11	O ₂ SENSOR STATUS
9	SENSOR	SENSOR TEMPERATURE
10	AMBIENT	AMBIENT AIR TEMPERATURE
11	Prs	PRESSURE MEASUREMENT
12	NATURAL GAS	FUEL SELECTED
13	K1g	SELECTED FUEL GROSS CALORIFIC VALUE
14	K1n	SELECTED FUEL NET CALORIFIC VALUE
15	K2	SELECTED FUEL MAX THEORETICAL CO ₂
16	K3	SELECTED FUEL MAX WET LOSS
17	K4	SELECTED FUEL ALPHA VALUE
18	REF%O ₂	O ₂ REFERENCE - mg/m ³ n MEASUREMENTS
19	NETT	NET FLUE GAS TEMPERATURE
20	FLUE	ACTUAL FLUE GAS TEMPERATURE
21	INLT	BOILER AIR INLET TEMPERATURE
22	O ₂	FLUE GAS OXYGEN CONTENT
23	XAIR	EXCESS AIR CALCULATION
24	CO	FLUE GAS CO CONTENT
25	CO ₂	FLUE GAS CO ₂ CALCULATION (CO ₂ m FLUE GAS CO ₂ MEASUREMENT)
26	CO/CO ₂ R	CO DIVIDED BY CO ₂ RATIO
27	PI	POISON INDEX CO/CO ₂ RATIO X 100
28	EFF	COMBUSTION EFFICIENCY CALCULATION
29	LOSS	TOTAL LOSSES CALCULATION
30	DRY	HIGH TEMPERATURE & EXCESS AIR LOSSES
31	WET	LATENT HEAT LOSSES
32	CO LOSS %	INCOMPLETE COMBUSTION LOSSES
33	NO	FLUE GAS NO CONTENT
34	NO ₂	FLUE GAS NO ₂ CONTENT
35	NOX	FLUE GAS NOX CALCULATION
36	SO ₂	FLUE GAS SO ₂ CONTENT
37	CxHy	HYDROCARBON MEASUREMENT
38	H ₂ xc	CO/H ₂ CROSS SENSITIVITY MEASUREMENT
39	AUX1	AUXILIARY 1 SENSOR MEASUREMENT
40	-----	DOTTED LINE
41	#####	STOPS PRINTOUT

FIRETRON PLUS LOGGING AND PC DOWNLOAD

Overview

Description

Data is sent to the handset through the connection lead and can be stored if required. All information logged can be displayed on the handset, down-loaded to a computer or output directly to a printer.

The handset will store up to a maximum of 1926 pages (standard Firetron Plus output). Information is stored each time the  key is manually pressed or an auto-timed print is requested.

The location number where the data is to be stored is displayed allowing it to be recorded on any paperwork e.g. job sheets.

Switching the Logger on

The logger can be operated either connected to the Firetron Plus or as a standalone unit, (batteries are required if not connected). To turn the logger on use the  switch, the following will be shown on the display followed by the MENU screen.



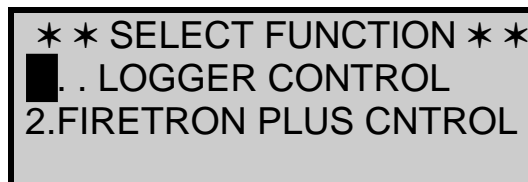

```
  ** FIREYE **  
TEL (603) 432-4100  
FAX (603) 432-1570
```



```
  ** SELECT FUNCTION **  
1. LOGGER CONTROL  
2. FIRETRON PLUS CNTROL
```

LOGGER MENU

A flashing cursor will be positioned over the number **1**, control of the cursor is through and  and . Move the cursor to the desired function and press enter to select.

To return to the MENU at any time press  and  simultaneously.

Logging Data

Data logging is done with the handset operating in **2. FIRETRON PLUS CONTROL** and by either pressing the  key or requesting an auto print, information will be captured by the logger and stored.

The display will show the following screen to confirm information has been stored correctly.

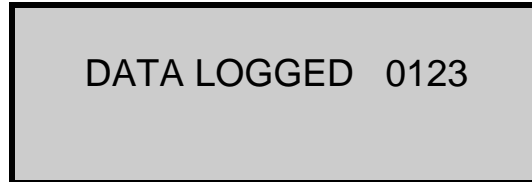

In the display shown above the data has been stored in location 123. Make a note of this on any paperwork you are using for that job so that the information can be retrieved later.

Batteries

The logging handset can either be powered from the Firetron Plus through the lead or from its own batteries. Batteries are inserted in the back of the logger by removal of the rear cover.



TIP: It is advised that batteries are used at all times to ensure no data is lost or corrupted.

Four 'AA' alkaline batteries can be used or a Nicad rechargeable equivalent, if Nicad batteries are used they can be recharged by plugging the Firetron Plus charger into the side of the handset. Typical recharge time is 12 hours.



Take care to insert batteries correctly; indication of polarity is in the battery enclosure.

Logger Control

This facility allows access to all of the information stored in the handset; data can be cleared, viewed on the display or output to a printer or PC. The logger records each page of Firetron Plus information and gives it a unique log number; as additional logs are sent to the handset the log number is increased by 1 until a maximum of 1926 pages is reached. Once the memory is full, data will STOP logging.

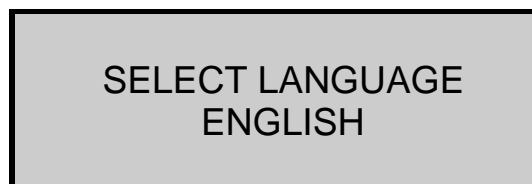

To select **1. LOGGER CONTROL** position the cursor on the 1 in the MENU using  and  and press . The first screen sets the language option,



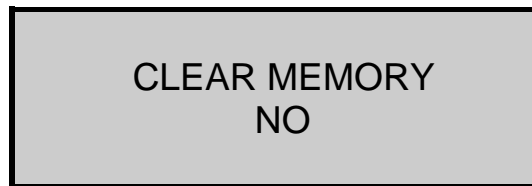

Parameter	Controls	Options
SELECT LANGUAGE	Use  and  to select the desired language, press  when correct	ENGLISH SPANISH NETHERLANDS FRENCH ITALIAN GERMAN SWEDISH FINNISH

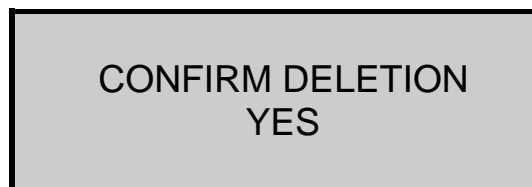

Clear Memory allows you to clear all stored information prior to logging during tests, this resets the log number to **0001** so that the first new log is given this number.

Select **YES** or **NO** using  and  press  . A warning display is shown and you are requested to confirm you want to delete all of the data stored !



Select **YES** or **NO** using  and  press  .



ENTER YES to tell the logger to store data in memory and **NO** to disable the logging function.

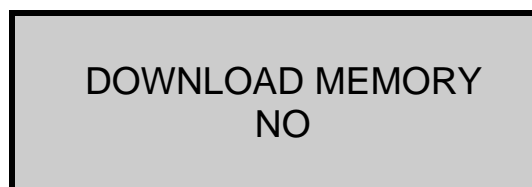



Download Memory allows you to output the stored information to a PC, output is in our own format and requires a special program to extract the data. Contact Fireeye® or Authorized Distributor for information on the 'Fireworks' range of software.

Selecting **YES** will set the handset in **READY** mode, this allows the PC software to access the data stored.

READY

Once the PC has extracted the data from the handset the logger will revert back to the **LOGGER MENU**.

WARNING ! The logger will stay in **READY** mode until all of the data is extracted from the handset. Do not enter this mode unless you are going to download data - you will have to switch the handset **OFF** if you do.

DISPLAY MEMORY
NO



Display Memory allows you to view stored information on the hand-set display.

Select YES to access the following screen.

DISPLAY MEMORY
SELECT 0000 TO 0123
0000

ENTER the desired location to display the memory **FROM**. Entering numbers is detailed in section 6.



LOG NO.	0100
DATE	23/10/96
TIME	10:32:36
BATTERY %	54

To scroll through data, use  and , note the log starts with the Log Number followed by Firetron Plus data. Note also that once at the top of a log the  will take you to the top of the previous log i.e.

LOG NO.	0099
DATE	23/10/96
TIME	10:31:36
BATTERY %	54

Using the  will scroll through that particular log moving one line at a time.

DATE	23/10/96
TIME	10:31:36
BATTERY %	54
INSTABILITY	1

To exit Display Memory, press  and  together and return to the **LOGGER DISPLAY**.

Downloading Information

Data can either be downloaded from the handset or stored directly in a PC real-time. To extract the data from the handset contact Fireeye® for information of the FIREWORKS range of software. The software allows information to be extracted from the handset or gather information from the PC.

Other features of the FIREWORKS software are:

- Graph and print stored and real-time data.
- Display information on bar graphs and large LED type display.
- Compile tuning reports and emissions reports.
- View data stored in tabular format.
- Export files to spreadsheet format.
- Allow the PC to act as a virtual handset and control the Firetron Plus.

Stored data cannot be extracted from the handset without the FIREWORKS software. Information can be captured from the RS232 on the Firetron Plus. A standard RS232 serial lead is required to connect the Firetron Plus RS232 to the PC serial port. Contact your computer supplier or Fireeye® for the required lead. Leads are supplied with the FIREWORKS software.

Setting Up Your PC

A standard communications package will be able to collect the data from the Firetron Plus. Windows Terminal software is a suitable package. The communications protocol should be set to:

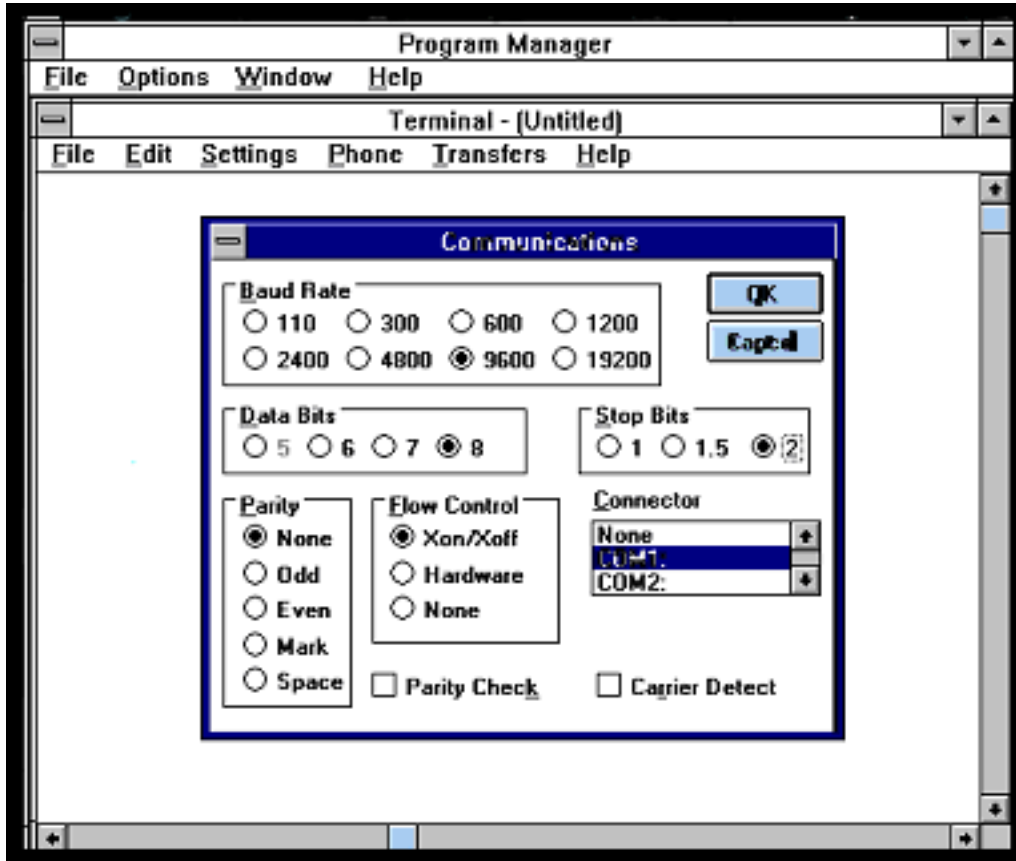

Capturing Data From Firetron Plus

To capture data direct from the Firetron Plus into a PC the RS232 port on the Firetron Plus has to be connected to the serial port on your PC. Using the standard RS232 lead, and IBM/AT lead if you serial port is a 9 pin D type, connect the Firetron Plus to the PC.

The RS232 can output in two formats, Comma Separated variable (CSV) and Binary (for the logger).

The standard default setting is binary and will always be set if the instrument is switched off and on. To change between the outputs press

SET/CAL
ENTER

followed by

AUX

The instrument will beep and change the output, repeat the key sequence to change back.



The format for the CSV output is as follows:

Time	Date	Instability	Battery	Sensor	Ambient	Pressure	Fuel
16:28:30	20-05-96	0	49	23.5	24.5	0.3	12

K1g	K1n	K2	K3	K4	O2 Reference	Nett temp	Flue temp
0.35	0.39	11.8	9.8	32	3	120	144

Inlet temp	Oxygen reading	Excess air	CO Reading	Calculation	Efficiency	Losses	Dry loss
N	8.3	28	55	3.5	83	17	8

Wet loss	CO Loss	NO	NO2	NOx	SO2	H2xc	Aux1	Aux2
7	2	20	N	21	N	12	N	N

The output will be as the example below:

16:28:30, 20-05-96, 0, 49, 23.5, 24.5, 0.3, 12, 0.35, 0.39, 11.8, 9.8, 32, 3, 120, 144, N, 8.3, 28, 55, 3.5, 83, 17, 8, 7, 2, 20, N, 21, N, 12, N, N

Where a number is not displayed the following meanings can be taken:

N = Not fitted

F = Fault

O = Over range (i.e. Oxygen reading 20.9% hence excess air can not be calculated)

Downloading Logged Data

The FIREWORKS software allows data to be downloaded from the handset. This section is supplied to explain how to set the handset in a state ready to transmit data.

Using the lead RE5PC supplied with FIREWORKS connect the 15 pin D connector to the handset and the 9 pin D connector to your PC serial port. Most PCs have a 9 pin D serial port if yours has a 25 pin contact your computer supplier for a converter.

Set the logger to **DOWNLOAD** data and ensure it is in **READY** mode.

NOTE: You will require batteries to run the logger and download the data.

CONTINUOUS MONITORING

The Firetron Plus is designed primarily as a portable emission monitoring analyzer. It can however be used for longer periods if the gas is treated correctly before being supplied to the analyzer.

The main problem with continuous monitoring is the build-up of water in the water trap. There are two methods available for extracting the water. Both are optional extras available:

- **Auto Draining** water trap with built-in level sensor. This connects via RS232 connections and will automatically drain the water trap if the level rises too high. The electronics in the water trap will also stop the Firetron Plus from pumping if the water level does not drop.
- **Gas Conditioning** with heated line and cooled chamber. This should be used when accurate NO₂ and SO₂ readings are required. A Main Purge solenoid should also be fitted to the Firetron Plus when monitoring for longer periods of time. This is to supply fresh air to the sensors and hence prevent them drying out. See Recommended Operation in next section.

Main Purge

The optional main purge facility for Firetron Plus is used where longer sampling of flue gas is required. It should be used with the FT93TTLV gas conditioning unit or in conjunction with any other water removal system. Contact Fireeye or an Authorized Distributor for more information.

If dry gas is supplied to the Firetron Plus for a long period of time the operating cells will dry out and stop working. Supplying fresh ambient air to the sensors on a periodic basis will prevent or reduce the drying effect and prolong sensor life. Ideally the fresh air should be at 50% relative humidity but it is understood under certain conditions this may not be possible.

Main purge introduces a solenoid valve into the gas train after the water trap connection to the Firetron Plus. With the purge turned OFF the instrument will draw gas from the probe and flue, with purge ON the solenoid is activated and the instrument draws fresh air from within its case. The solenoid can be switched either manually or through a timed operation.

Manual Operation

This function allows the user to switch the solenoid ON or OFF manually through pressing a sequence of keys. It can be performed at any time during Firetron Plus operation but has no effect during a timed operation.

ON/OFF Toggle operation





Timed Operation

This requires the user to set the following:

Purge duration - The amount of time fresh air is draw into the instrument. This can be set between 5 and 30 minutes and is a function of the gas concentration and the humidity of the ambient air. For dry ambient conditions and high gas concentrations, a longer purge duration should be set.

Purge interval - This is the time between purge operations, i.e. the time the instrument is sampling gas. It can be set between 9 and 99 minutes.

Auto zero - Allows all toxic cells to be set to zero and the oxygen cell to 20.9% on completion of the purge cycle. For example, if 10 minutes is set in the 'Purge duration', the cells would be Auto zeroed after that time. Note, allow sufficient time for the cells to return to zero. If concentrations of gas are high then a long purge duration should be set.

NOTE: If the analyzer is positioned where levels of gases are higher than fresh air ambient conditions then auto zero should not be used.

To access timed purge enter the following:

SET/CAL
ENTER

SET/CAL
ENTER

Enter the code 0000 at the following display:

ENTER SERVICE CODE
- - - - - > 0 0 0 0 < - - - - -

The following screens will be displayed, enter NO to both:

CALIBRATE SENSOR
NO

PRINT MEMORY ?
NO



The purge sequence now begins, by using the arrow keys select YES to 'SET PURGE ?' and press

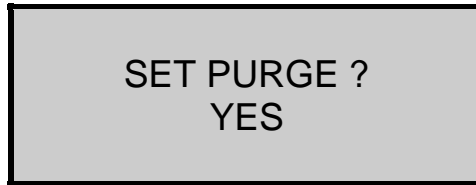

Enter the purge duration and similarly the purge interval by changing each character. Note the cursor below the zero indicates the number to be changed. Press enter when correct. If a time of less than the minimum (5) or greater than the maximum (9) is entered, then these will set as the default values.

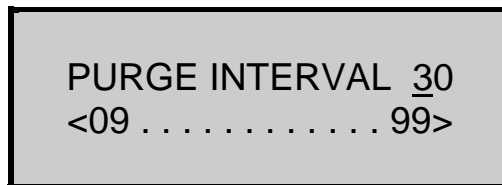
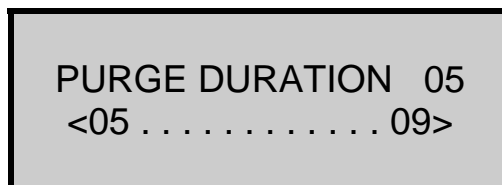

Set YES or NO depending on whether auto zero is required or not.



Note: During both Manual and Timed purge operation the following screen will be displayed for approximately one second every 3 seconds.

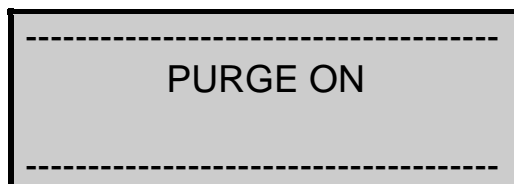



Recommended Operation

Each monitoring situation will be different and a degree of user judgement will apply. The following basic guidelines should be followed:

- Maximum duration without purge 4 hours followed by 40 minutes purge.
- For monitoring up to 12 hours per day purge should be for 10 minutes every hour.
- For monitoring up to and over 24 hours per day purge should be for 10 minutes every 30 minutes. This could be a sequence of 5 minutes purge followed by 10 minutes sample.

Sensor Over-range

The main purge will also operate when any gas concentration goes over the stated range of that sensor. Fresh air will be drawn into the Firetron Plus until the gas level is down to 80% of the sensor range.

MAINTENANCE

Emptying and Cleaning the In-line Water Trap

The water trap should be checked and emptied on a regular basis. Water vapor will condense and gather in the probe line this may move suddenly to the trap when the probe is moved. Care should be taken at all times.

Emptying of the water trap is detailed below:

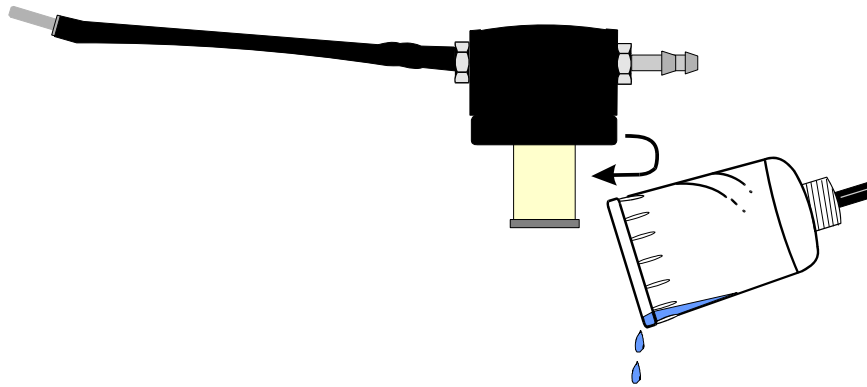

Carefully remove the end cap from the in-line housing. Dispose of the condensation in a suitable drain - care must be taken as it could be acidic. If condensation spills onto the skin or clothing, clean off

immediately using fresh water; seek medical advice if problems occur.

Changing the Particle Filter

This is a very important part of the analyzer and should be changed regularly. It prevents dust and dirty particles entering the pump and sensors and hence causing damage. The filter **MUST** be changed when it appears discolored.

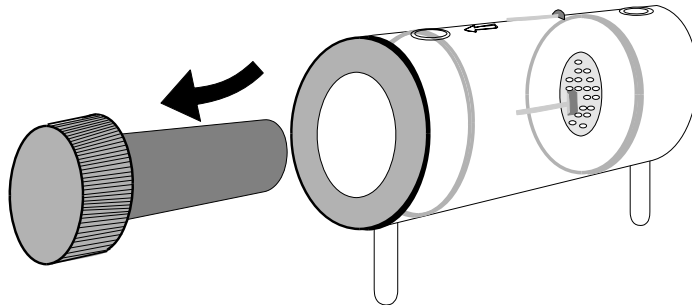

Remove the end cap from the filter housing. Carefully remove the paper filter element and dispose of it. Clean the inside of the filter housing with a suitable soft cloth. Insert a new filter element onto the spigot on the filter end cap and carefully insert it into the filter body.

Charging the Battery

It is important that the battery is charged on a regular basis. The instrument constantly powers the internal sensors and may discharge the battery if left unattended for some months. Connect the charger supplied with the instrument to the correct mains supply.

Note: The correct charger type is required for your local voltage i.e. 110 or 220 volts AC

Insert the plug in the socket marked CHARGER INPUT SOCKET as detailed on page 5.

The CHARGER ON GREEN LED will illuminate showing the instrument is charging.

Changing the Paper Roll

To change the paper roll, remove the printer cover by loosening the two screws holding it down. Remove the old paper roll core and insert the new roll so that it sits as follows:

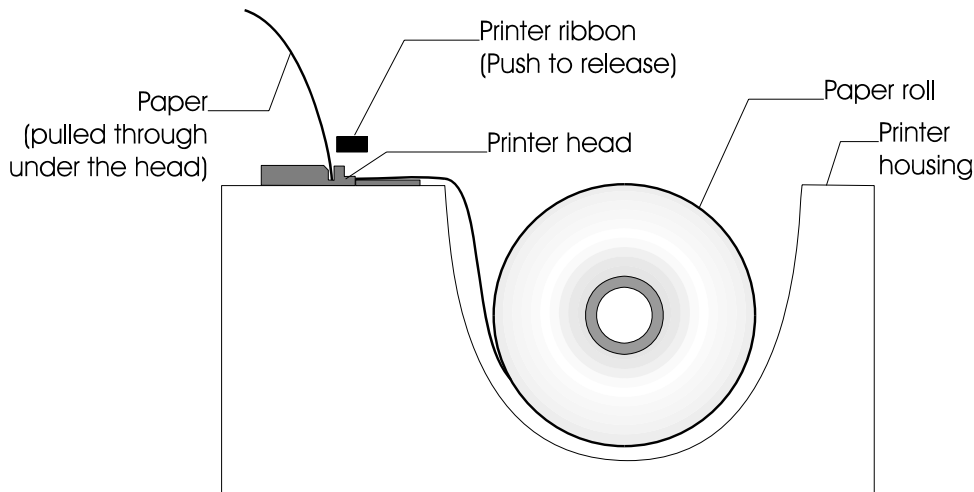

Feed the free end of paper into the printer through the metal slot beneath the printer ribbon. Start the paper feed sequence until the paper has emerged from the top of the printer, feed the loose end through the cover and refit.

TO START PAPER FEED

Press the **SET/CAL** followed by

UPPER FUNCTION key



Pressing the **PRINT** key displays

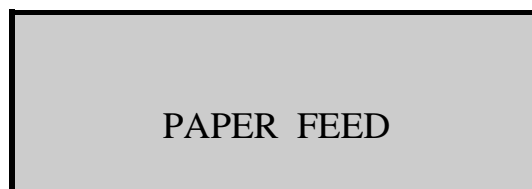

Press any key to stop.

Changing the Printer Ribbon

The printer ribbon cartridge will last for approximately two rolls of paper. Remove the printer cover as described on previous page.

Customization of the details will extend the life of the ribbon and paper printout. See page 34 for details.

Marked on one end of the cartridge is PUSH. Gently press down on this end and the ribbon cartridge will pop up at the other end. Remove the cartridge and dispose of.

Fit a new ribbon guiding the paper roll between the exposed ribbon and cartridge body.

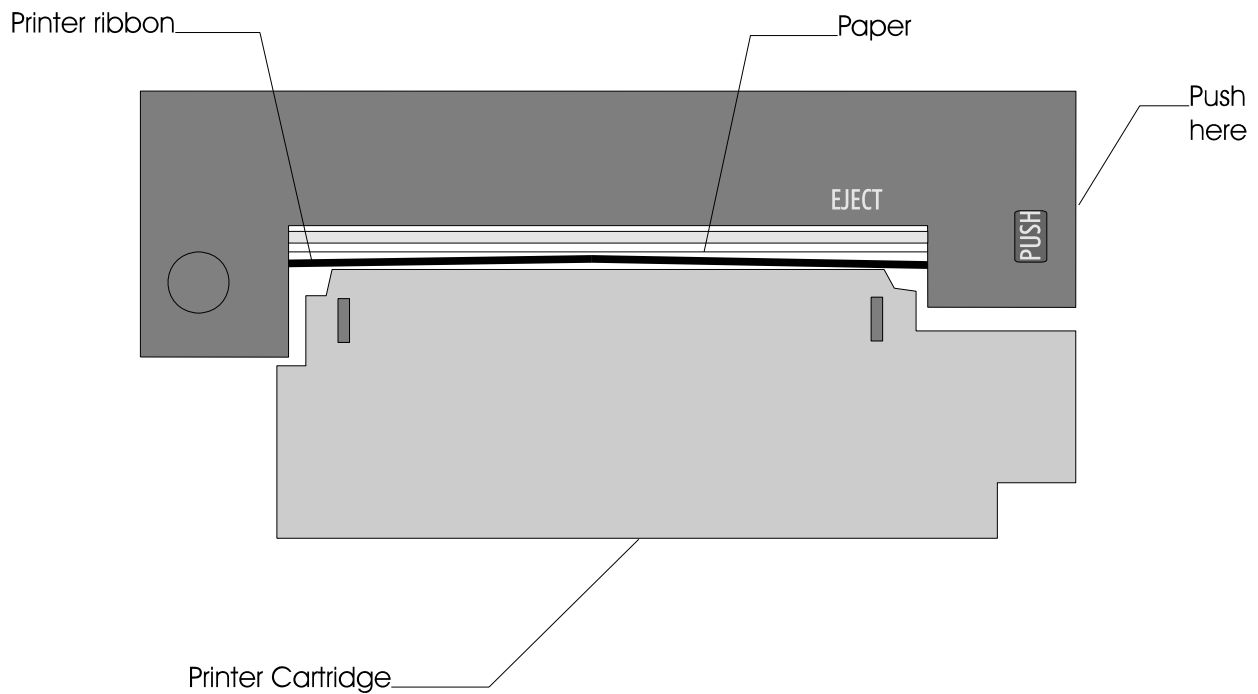

Refit printer cover.



PROBLEM SOLVING

The following is a list of problems that may occur on the instrument through its operating life. If the cause of the fault is not easy to identify then we advise you to contact the Fireye® Service Department or an Authorized Distributor for expert advice.

Fault symptom	Causes
<ul style="list-style-type: none">• Oxygen too high• CO₂ too low	<ul style="list-style-type: none">• Air leaking into probe, tubing, water trap, connectors or internal to instrument.• Oxygen cell needs replacing.
<ul style="list-style-type: none">• Oxygen Error (FAULT)• Toxic sensor Error (FAULT)	<ul style="list-style-type: none">• Calibration time set too short and instrument not allowed to stabilize• Instrument has been stored in a cold environment and is not at normal working temperature.• Oxygen cell or toxic sensors need replacing.
<ul style="list-style-type: none">• Analyzer not holding charge• Analyzer not charging	<ul style="list-style-type: none">• Battery exhausted.• AC charger not giving correct output.• Fuse blown in charger plug.
<ul style="list-style-type: none">• Analyzer does not respond to flue gas	<ul style="list-style-type: none">• Particle filter blocked.• Probe or tubing blocked.• Pump not working or damaged with contaminants.• Probe connected to pressure connector.
<ul style="list-style-type: none">• Flue temperature readings erratic	<ul style="list-style-type: none">• Temperature plug reversed in socket.• Faulty connection or break in cable or plug.
<ul style="list-style-type: none">• Analyzer automatically switches off in operation.	<ul style="list-style-type: none">• Battery below alarm level.• Battery quickly discharging and is faulty.
<ul style="list-style-type: none">• Display is blank.	<ul style="list-style-type: none">• The contrast setting has been lost and requires resetting. Disconnect handset lead and reconnect. Set contrast as shown on page 16.



ANNUAL RE-CALIBRATION

While the sensors have an expected life of more than two years in normal use it is recommended that the analyzer is re-calibrated at least annually. This is so that long-term drift on the sensors and electronics can be eliminated. Local regulation may require more frequent re-calibration and users should check with appropriate authorities to ensure they comply with relevant guidelines.

HOW TO GET EXPERT HELP

There will be occasions when despite having read the manual there will be problems that you cannot resolve and so you need external help.

Before calling Fireye® or one of our Authorized Distributors please first check the following:

Find the serial number of the instrument. It is located on the label close to where the charger and handset leads plug into the analyzer. Also, make a note of which sensors are fitted by observing the tick boxes on the same label.

If the handset and analyzer are operating you can also determine the issue of software loaded in the analyzer. To find this, complete the start-up calibration routine and then press  twice .

The display will show

Use the  key to change the numbers



ENTER SERVICE CODE
-----> 0 0 0 0 <-----

Then press  to step to the next number

You need to enter

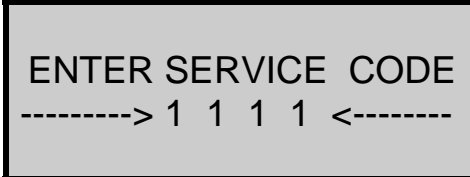

ENTER SERVICE CODE
-----> 1 1 1 1 <-----

Press  again and the display will show

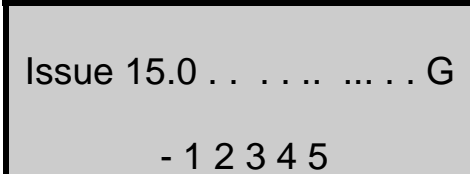

Issue 15.0 G
- 1 2 3 4 5



Please record the issue number.
Press any key to exit this mode.

When you call Fireye please have this information available so that the technician has the best chance of being able to help you. If you have a modem you may be asked to connect the RS232 interface of the analyzer to your modem so that the technician can operate the analyzer remotely and extract from it information stored in its memory that might help to resolve your problem.

PRODUCT SPECIFICATION

INSTRUMENT

Parameter	Resolution	Accuracy	Range
Temp Measurement			
Flue Temperature	0.1° (C/F)	1.0° C +/-0.3% of reading	0 - 1100°C, 32 - 2140°F * Use high temperature probe for gases > 600°C/1112°F
Inlet Temperature	0.1° (C/F)	1.0° C +/-0.3% of reading	0 - 600°C 0-999°F
Gas Measurement			
Oxygen (O ₂):	0.1%	-0.1% +0.2%	0-25%
Carbon Monoxide (CO):	1ppm	+/-20ppm < 400ppm 5% of reading < 2000ppm +/- 10% of reading >2000ppm	0 - 10,000ppm
Carbon Monoxide (CO):	0.01%	+/- 5% of reading from 0.1% to 10%	0 - 10%
Nitric Oxide (NO):	1ppm	+/- 5ppm < 100ppm +/-5% of reading >100ppm	0 - 1,000ppm
Nitrogen Dioxide (NO ₂):	5ppm	+/-5ppm < 100ppm +/- 10ppm < 500ppm	0 - 10,000ppm
NitrogenOxide (NO) ^H :	1ppm	+/-5% of reading > 500ppm	0 - 5,000ppm
Pressure:	0.01mbar/kpa	+/-5% of reading >100ppm	0 - 150mbar
Sulfur Dioxide (SO ₂):	0.1%	+/-0.5% Full scale	0 - Fuel Value
Carbon Dioxide (CO ₂):	0.1%	+/-7% of reading +/-0.4%	0-100%
Carbon Dioxide (CO ₂) ^{*2} :	0.01%	+/-0.3%	+/-5% of reading
Efficiency ^{*2} :		+/-1%	
Hydrocarbons (HC):		0-5% Methane (LEL)	

*1 Using dry gases at STP

*2 Calculated

LEL = Lower Explosive Limit



HANDSET

Dimensions	220 mm (8.7in) long 120 mm (4.7in) wide 50 mm (2in) high
Keypad	16 tactile keys with sounder
Display	4 line LCD with backlight and contrast control

EXTENSION CABLE

Specification:	8 pin DIN to 15 pin 'D' screened cable
Cable lengths:	5m (16.4ft) Standard 10-20m (32-65ft) -Optional

PROBE

Choose from a range of probe options. See probe leaflet.

BATTERY

Type:	Lead acid rechargeable (12V, 2 AH)
Life:	8 hours from full charge
Charge time:	12 hours

BATTERY CHARGER

Input:	110-120V AC/220-240V AC.
Output:	16V AC (RMS)@ 1 amp, 50-60 hz.

PUMP

Flow rate:	2 Liters/Minute nominal
------------	-------------------------

PRINTER

16 character dot matrix.

RS232

25 way plug connector,
9600 Baud,
No parity,
8 Data bits,
2 Stop bits.



FIRETRON PLUS	PC
Pin 2: TXD	Pin 2: TXD
Pin 3: RXD	Pin 3: RXD
Pin 4: RTS	Pin 4: RTS
Pin 5: CTS	Pin 5: CTS
Pin 7: Ground	Pin 7: Ground

AMBIENT OPERATING RANGE

0 - 40°C (+32°F to 104°F)

20 - 80% RH non condensing

Storage: 0-50°C (+32°F to 122°F)

Maximum gas temperature at sensors:

Continuous +40°C (104°F)

Intermittent +55°C (122°F)

APPENDICES

A - Parameter Meanings

The parameters and their meanings are detailed as follows: -

- DATE :** Analyzer date. See page 18 to change.
- TIME :** Analyzer time. See page 18 to change.
- INSTABILITY :** This is an indication of how stable the signals are from all the sensors. 0 = high stability, 10 = high instability. When measuring flue gases, pressure and temperature this number will rise as the sensed inputs varies. At start up when sampling fresh air this number is invariably 0.
- BATTERY :** Displays the battery level from 0-100%. The analyzer will flash **RECHARGE BATTERY** at less than 10 % of charge. The analyzer may show levels greater than 100% when the charger connected.
- FUEL :** The fuel used in calculation of efficiency and Carbon Dioxide.
- K1g:** Gross calorific fuel constant. See Appendix C for calculation.
- K1n:** Gross calorific fuel constant. See Appendix C for calculation.
- K2:** Percentage Maximum theoretical CO₂ (dry basis).
- K3:** Percentage wet loss.
- K4:** Percentage unburned carbon loss.
- O2r:** Toxic gas measurements can be referenced to defined oxygen levels.

Oxygen referencing is required by some regulations such as TITLE V. If a reference value is selected the toxic gas measurements will be displayed with the symbol **n** attached to the units. i.e. ppmn

What does Oxygen reference mean ?

If 3 % O₂ reference is selected and 5 % O₂ is measured in the flue then toxic gas values will be recalculated as if 3 % were measured. The equation for referencing is detailed in the Appendix.

Oxygen referencing prevents false readings being submitted, e.g. allowing more air into the boiler will increase the oxygen level in the flue and hence dilute any toxic gas reading. Oxygen referencing gives readings as if they were undiluted.



- NET:** Net temperature calculated by deducting the internal AMBIENT temperature from the measured FLUE temperature. Displays in either Centigrade C or Fahrenheit F and will display NOT FITTED if flue probe not connected.
- If an external INLET probe is used then INLET is deducted from FLUE.
- O2:** Oxygen reading in percentage %.
- CO:** Carbon Monoxide reading indicated in ppm or mg/m³. If the figures are referenced to oxygen then the display will show **ppmn** or **mg/m³n**. See page 25 for oxygen reference. Note with a high CO sensor fitted the reading will be displayed in percentage %.
- EFF (G):** Combustion Efficiency calculation displayed in percentage. Gross G or Net N can be set see page 22. The calculation is determined by fuel type see Appendix B for calculation. The efficiency is displayed during a combustion test, 00.0 is displayed while in fresh air.
- CO2m:** Carbon Dioxide reading in percentage %
- CO2:** Carbon Dioxide calculation determined by the type of fuel. This only shows a reading when a combustion test is being carried out. Zero (0.0) is displayed while in fresh air.
- FLUE:** Temperature measured by flue gas probe in Centigrade or Fahrenheit. Will show ambient temperature after fresh air calibration and **NOT FITTED** or **FAULT** if probe disconnected.
- INLET:** Temperature measured by the optional inlet air probe or stored using the Flue probe. The air probe is plugged into the instrument through the INLET socket. This figure is used to calculate the NET temperature instead of AMBIENT when fitted.
- AMBIENT:** Temperature measured by the internal sensor, used in the NET temperature
- CO/CO₂ R:** The CO/CO₂ ratio, is the ratio of measured CO divided by CO₂.

It gives an indication of the following:

- How good a gas sample the instrument is reading.
- How clean the boiler is running.



For example: A new or clean domestic boiler will display a ratio of less than 0.004, a unit in need of cleaning 0.004-0.008 and a unit in need of major overhaul will show greater than 0.008.

This only shows a reading when a combustion test is being carried out. 0.0000 is displayed while in fresh air.

- P INDEX:** The CO/CO₂ ratio expressed as a percentage %, called the “Poison Index” i.e. P INDEX % = 100 x CO/CO₂. 0.00 is displayed while in fresh air.
- XAIR %:** Excess air calculated from the measured oxygen and type of fuel used. Displays reading during combustion test. O₂ > 20% is displayed while in fresh air.
- PRs:** Flue draft pressure reading. Displayed when pressure sensor fitted. See page 11 to take a reading and page 25 for changing the scale.
- NO:** Nitric Oxide reading in ppm or mg/m³. Displayed when Nitric Oxide sensor fitted. Reading can also be referenced to oxygen ppmn or mg/m³n.
- NO₂:** Nitrogen Dioxide reading in ppm or mg/m³. Displayed when Nitrogen Dioxide sensor fitted. Reading can also be referenced to oxygen ppmn or mg/m³n.
- NO_x:** Calculated total Nitric oxides displayed in ppm or mg/m³. For more details on NO_x calculation see page 23 Scale Options. Reading can also be referenced to oxygen ppmn or mg/m³n.
- SO₂:** Sulfur Dioxide reading in ppm or mg/m³. Displayed when Sulfur Dioxide sensor fitted. Reading can also be referenced to oxygen ppmn or mg/m³n.
- CxHy:** Unburned HydroCarbon reading in % of LEL of Methane, the sensor is calibrated with Methane. Displayed when a HydroCarbon sensor fitted.
- LEL is the Lower Explosive Limit of a gas when mixed with air, for Methane this has the ratio of 19:1 Air:Methane. Below the LEL the mixture can not ignite and burn. In the Flue an unburned HydroCarbons should be well below this level or there is the potential for an explosion.
- LOSS:** Total losses calculated from Combustion Theory. This is the summation of the next three parameters.
- DRY:** Calculated heat lost in turning the Carbon in the fuel to Carbon Dioxide (CO₂).
- WET:** Calculated heat lost in turning the Hydrogen in the fuel into water (H₂O).



- CO LOSS %:** Calculated loss due to partially burned Carbon. Any Carbon Monoxide (CO) in the flue has the potential to be turned into Carbon Dioxide and release more heat, hence this heat is lost up the flue.
- OS11 %:** Oxygen sensor life indicator. This is an approximation calculated from the output voltage of the sensor in **fresh air**. Note! This is not valid when a combustion test is being performed.
- H2xc:** The Carbon Monoxide sensor is Hydrogen compensated. This parameter is the reading from the Hydrogen sensor built into CO sensor. It is an indication of the level of Hydrogen in the flue and can NOT be used as an exact level, it is only used to cross compensate the CO sensor.
- AUX1:** Auxiliary sensor position, to be used for future sensors.

B. NO_x CALCULATIONS

ONLY a NO Sensor fitted.

working in ppm: NO_x referenced to NO

The user can select the **assumed NO₂ percentage** and the **O₂ normalized** level

then: $NO_x \text{ in ppm} = NO \text{ in ppm multiplied by } (1 + \text{assumed } NO_2 \text{ percentage})$

in this setup NO_x can only be displayed as NO_x = NO

then normalizing:

$NO \text{ in ppmn} = NO \text{ in ppm multiplied by } (21 \text{ minus the } O_{2norm} \text{ setting}) \text{ and then divided by } (21 \text{ minus the actual } O_2 \text{ reading})$

For a worked example assume:

NO is 1000ppm
NO₂ is 5% of NO
O_{2norm} is set to 3%
actual O₂ is zero

$$NO_x \text{ in ppm} = 1000 \times (1 + 5/100) = 1000 \times 1.05 = \mathbf{1050} \text{ ppm}$$

$$NO \text{ ppm n} = 1000 \times (21 - 3)/(21 - 0) = 1000 \times 18 / 21 = \mathbf{857} \text{ ppm n}$$

$$NO_x \text{ ppm n} = \mathbf{1050} \times 18 / 21 = 900 \text{ ppm n}$$

or

$$NO_x \text{ ppm n} = \mathbf{857} \times 1.05 = 900 \text{ ppm n}$$

working in mg/m³: NO_x referenced to NO or NO₂

The user can select the assumed NO₂ percentage, the O₂ reference level and whether the NO_x reading is referenced to NO or NO₂

referenced to NO

$$NO \text{ in mg/m}^3 = NO \text{ in ppm multiplied by } 1.34$$

$$NO_x \text{ in mg/m}^3 = NO \text{ in mg/m}^3 \text{ multiplied by } (1 + \text{assumed } NO_2 \text{ percentage})$$

NO_x referenced to NO₂

NO_x in mg/m³ = NO in ppm multiplied by 2.05 multiplied by (1 + assumed NO₂ percentage)

or

NO_x in mg/m³ = NO in mg/m³ divided by 1.34, multiplied by 2.05 and multiplied by (1 + assumed NO₂ percentage)

Normalizing readings

Normalized reading = initial reading multiplied by (21 minus the O_{2norm} setting) and then divided by (21 minus the actual O₂ reading)

BOTH NO and NO₂ sensors Fitted

Working in ppm *NO_x = NO + NO₂*

Normalizing readings

ppmn = initial reading in ppm multiplied by (21 minus the O_{2norm} setting) and then divided by (21 minus the actual O₂ reading)

Working in mg/m³

The user can select how the readings are referenced.

NO_x = SUM

NO_x = NO

NO_x = NO₂

NO_x = SUM

NO_x in mg/m³ = NO in ppm multiplied by 1.34 plus NO₂ in ppm multiplied by 2.05

NO_x = NO

NO_x in mg/m³ = (NO in ppm plus NO₂ in ppm) multiplied by 1.34

NO_x = NO₂

NO_x in mg/m³ = (NO in ppm plus NO₂ in ppm) multiplied by 2.05



Normalizing readings

ppm_n = initial reading in ppm multiplied by (21 minus the O_{2norm} setting) and then divided by (21 minus the actual O_2 reading)

mg/m³_n = initial reading in mg/m³ multiplied by (21 minus the O_{2norm} setting) and then divided by (21 minus the actual O_2 reading)

ONLY an NO₂ sensor fitted

When there is only an NO₂ sensor fitted the NO_x function is disabled

$$NO_2 \text{ in } mg/m^3 = NO_2 \text{ in } ppm \text{ multiplied by } 2.05$$

Normalizing readings

ppm_n = initial reading in ppm multiplied by (21 minus the O_{2norm} setting) and then divided by (21 minus the actual O_2 reading)

mg/m³_n = initial reading in mg/m³ multiplied by (21 minus the O_{2norm} setting) and then divided by (21 minus the actual O_2 reading)

C. COMBUSTION EFFICIENCY CALCULATION

The efficiency calculation is based upon British Standard BS845.

This identifies three sources of loss associated with fuel burning:

Losses due to flue gasses: Dry Flue gas loss,
Moisture and hydrogen
Sensible heat of water vapor
Unburned gas

Losses due to refuse: Combustible in ash
Combustible in riddlings
Combustible in dust

Other losses: radiation
convection
conduction
other unmeasured losses

Net efficiency calculations assume that the energy contained in the water vapor (formed as a product of combustion and from wet fuel) is recovered and the wet loss term is zero. Gross efficiency calculations assume that the energy contained in the water vapor is not recovered.

Since the fuel air mixture is never consistent there is the possibility of unburned/partially unburned fuel passing through the flue. This is represented by the unburned carbon loss.

Losses due to combustible matter in ashes, riddlings, dust and grit, radiation, convection and conduction are not included.

Efficiency Calculation:

Known Data - Fuel: Q_{gr} = Gross Calorific Value (kJ/kg)
 Q_{net} = Net Calorific Value (kJ/kg)
 $K1$ = Constant based on Gross or Net Calorific Value:
 $K1g = (255 \times \% \text{Carbon in fuel}) / Q_{gr}$
 $K1n = (255 \times \% \text{Carbon in fuel}) / Q_{net}$
 $K2$ = % max theoretical CO_2 (dry basis)
 $K3$ = % Wet Loss

Measured Data: T_f = Flue Temperature
 T_i = Inlet Temperature
 O_{2m} = % Oxygen in flue gas

Calculated data: T_{net} = Net Temperature
 % CO₂ content in flue gas
 % Dry Flue Gas losses
 % Wet losses
 % Unburned carbon loss
 % Efficiency

%CO₂ = $(20.9 - \%O_{2m}) \times K2 / 20.9$

T_{net} = Flue Temperature - Inlet Temperature

Dry flue gas loss = $20.9 \times K1n \times (T_{net}) / K2 \times (20.9 - \%O_{2m})$

Wet loss
simplified = $9 \times \%H_2 + \%H_2O / Q_{gr} \times [2488 + 2.1T_f - 4.2 T_i]$
 = $[(9 \times \%H_2 + \%H_2O) / Q_{gr}] \times 2425 \times [1 + 0.001 T_{net}]$

Wet loss = $K3(1+0.001 \times T_{net})$

Where K3 = $[(9 \times \%H_2 + \%H_2O) / Q_{gr}] \times 2425$

Net Efficiency = 100% - dry flue gas losses
 = $100\% - 20.9 \times K1n \times (T_{net}) / K2 \times (20.9 - \%O_{2m})$

Gross Efficiency = 100% - {dry flue gas losses + wet losses}
 = $100\% - [20.9 \times K1g \times (T_{net}) / K2 \times (20.9 - \%O_{2m}) +$
 $[K3 \times (1 + 0.001 \times T_{net})]$

Excess Air = $[(20.9\% / (20.9\% - O_{2m}\%)) - 1] \times 100\%$

CO₂% = $[(20.9\% - O_{2m}\%) \times K2\% / 20.9\%]$

Unburned fuel Loss = $K4 \times CO\% / (CO\% + CO_2\%)$
 Where K4 = 70 for coke
 = 65 for anthracite
 = 63 for Bituminous coal
 = 62 for coal tar fuel
 = 48 for liquid petroleum fuel
 = 32 for natural gas

The formula for K4 is based on the gross calorific value Q_{gr}. To obtain the loss based on net calorific value multiply by Q_{gr}/Q_{net}. Since this loss is usually small this conversion has been ignored.

Oxygen Reference CO(n) = CO x $\frac{(20.9 - O_{2f})}{(20.9 - O_{2m})}$

D. CALCULATION OF FUEL DATA

For any fuel not specified by Fireeye® the net calorific value, gross calorific value and composition should be obtained from the fuel supplier.

The following fuel data has been calculated with reference to the efficiency calculation.

Example 1:

Chemical composition:	C	25%	
	H ₂	3%	
	H ₂ O	50%	
	Q _{net}	8.35 MJ/kg	
	Q _g	9.3 MJ/kg	*
	Max CO ₂	20.4%	

$$\begin{aligned} \mathbf{K1n} &= (255 \times \% \text{ carbon in fuel}) / Q_{\text{net}} \text{ (kJ/Kg)} \\ &= (255 \times 25) / 8350 = 0.763 \end{aligned}$$

$$\begin{aligned} \mathbf{K1g} &= (255 \times \% \text{ carbon in fuel}) / Q_{\text{g}} \text{ (kJ/Kg)} \\ &= (255 \times 25) / 9300 = 0.685 \end{aligned}$$

$$\mathbf{K2} = \text{Max \% CO}_2 = 20.40$$

$$\begin{aligned} \mathbf{K3} = \text{Wet Loss} &= [(9 \times \% \text{H}_2 + \% \text{H}_2\text{O}) / 9300] \times 2425 \\ &= [(9 \times 3 + 50) / 9300] \times 2425 \\ &= (77 / 9300) \times 2425 = 20.08 \end{aligned}$$

$$\mathbf{K4} = \mathbf{65} \text{ (an approximation for wood) } *$$

The fuel values to program into the Analyzer are as follows:

NATURAL GAS			
K1g	: 0.763	K1n	: 0.685
K_2	: 20.4	K_3	: 20.08
K_4	: 65	O2r	: 8.0

* Assumed values in the absence of supplied data. See previous appendix for other fuels.

E. ELECTROMAGNETIC COMPATABILITY (CE) STATEMENT



This product has been tested for compliance with the following generic standards:

EN 50081-1

EN 50082-1

and is certified to be compliant

Specification EC/EMC/KI/FIRETRON PLUS details the specific test configuration, performance and conditions of use.





NOTICE

When Fireeye products are combined with equipment manufactured by others and/or integrated into systems designed or manufactured by others, the Fireeye warranty, as stated in its General Terms and Conditions of Sale, pertains only to the Fireeye products and not to any other equipment or to the combined system or its overall performance.

WARRANTIES

FIREYE guarantees for *one year from the date of installation or 18 months from date of manufacture* of its products to replace, or, at its option, to repair any product or part thereof (except lamps, electronic tubes and photocells) which is found defective in material or workmanship or which otherwise fails to conform to the description of the product on the face of its sales order. **THE FOREGOING IS IN LIEU OF ALL OTHER WARRANTIES AND FIREYE MAKES NO WARRANTY OF MERCHANTABILITY OR ANY OTHER WARRANTY, EXPRESS OR IMPLIED.** Except as specifically stated in these general terms and conditions of sale, remedies with respect to any product or part number manufactured or sold by Fireeye shall be limited exclusively to the right to replacement or repair as above provided. In no event shall Fireeye be liable for consequential or special damages of any nature that may arise in connection with such product or part.



FIREYE
3 Manchester Rd.
Derry, NH 03038 USA
www.fireeye.com

FT-9101
MAY 24, 2005